



Operator's Manual

Z-45 XC

CE

with
Maintenance
Information

Original Instructions
First Edition
First Printing
Part No. 1268193GT

Contents

Introduction	1
Symbol and Hazard Pictorials Definitions.....	5
General Safety	7
Personal Safety.....	10
Work Area Safety	11
Legend	20
Controls.....	21
Inspections	29
Operating Instructions.....	42
Transport and Lifting Instructions	50
Maintenance	53
Specifications.....	57

Copyright © 2017 Terex Corporation

First Edition: First Printing, January 2017

Genie and "Z" are registered trademarks of Terex South Dakota, Inc. in the U.S.A. and many other countries.

 Complies with EC Directive 2006/42/EC
See EC Declaration of Conformity

Introduction

About this manual

Genie appreciates your choice of our machine for your application. Our number one priority is user safety, which is best achieved by our joint efforts. This book is an operation and daily maintenance manual for the user or operator of a Genie machine.

This manual should be considered a permanent part of your machine and should remain with the machine at all times. If you have any questions, contact Genie.

Product Identification

The machine serial number is located on the serial label.

Serial number stamped on chassis	Serial label (located under cover)
-------------------------------------	---------------------------------------

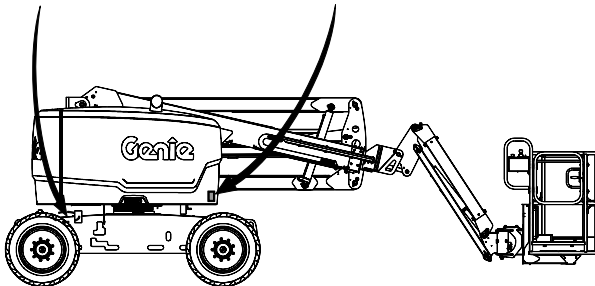

Intended Use

This machine is intended to be used only to lift personnel, along with their tools, and materials to an aerial work site.

Bulletin Distribution and Compliance

Safety of product users is of paramount importance to Genie. Various bulletins are used by Genie to communicate important safety and product information to dealers and machine owners.

The information contained in the bulletins is tied to specific machines using the machine model and serial number.

Distribution of bulletins is based on the most current owner on record along with their associated dealer, so it is important to register your machine and keep your contact information up to date.

To ensure safety of personnel and the reliable continued operation of your machine, be sure to comply with the action indicated in a respective bulletin.

Introduction

Contacting the Manufacturer

At times it may be necessary to contact Genie. When you do, be ready to supply the model number and serial number of your machine, along with your name and contact information. At minimum, Genie should be contacted for:

Accident reporting

Questions regarding product applications and safety

Standards and regulatory compliance information

Current owner updates, such as changes in machine ownership or changes in your contact information. See Transfer of Ownership, below.

Transfer of Machine Ownership

Taking a few minutes to update owner information will ensure that you receive important safety, maintenance and operating information that applies to your machine.

Please register your machine by visiting us on the web at www.genielift.com or by calling us toll free at 1-800-536-1800.

Introduction



Danger

Failure to obey the instructions and safety rules in this manual will result in death or serious injury.

Do Not Operate Unless:

- You learn and practice the principles of safe machine operation contained in this operator's manual.
 - 1 Avoid hazardous situations.**

Know and understand the safety rules before going on to the next section.
 - 2 Always perform a pre-operation inspection.
 - 3 Always perform function tests prior to use.
 - 4 Inspect the workplace.
 - 5 Only use the machine as it was intended.
- You read, understand and obey the manufacturer's instructions and safety rules—safety and operator's manuals and machine decals.
- You read, understand and obey employer's safety rules and worksite regulations.
- You read, understand and obey all applicable governmental regulations.
- You are properly trained to safely operate the machine.

Introduction

Safety Sign Maintenance

Replace any missing or damaged safety signs. Keep operator safety in mind at all times. Use mild soap and water to clean safety signs. Do not use solvent-based cleaners because they may damage the safety sign material.

Hazard Classification

Decals on this machine use symbols, color coding, and signal words to identify the following:



Safety alert symbol—used to alert you to potential personal injury hazards. Obey all safety messages that follow this symbol to avoid possible injury or death.



Indicates a hazardous situation which, if not avoided, will result in death or serious injury.



Indicates a hazardous situation which, if not avoided, could result in death or serious injury.









Indicates a hazardous situation which, if not avoided, could result in minor or moderate injury.



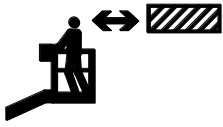
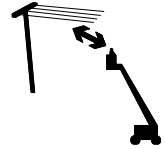

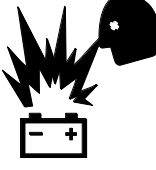



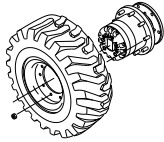

Indicates a property damage message.

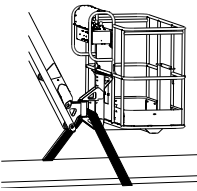
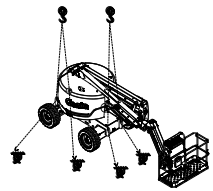
Symbol and Hazard Pictorials Definitions

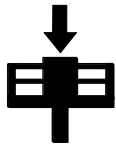
				
Crush hazard	Keep away from moving parts	Read the operator's manual	Overhead obstruction	Collision hazard
				
Electrocution hazard	Maintain required clearance	Tip-over hazard	Tip-over hazard	Tip-over hazard
				
Electrocution hazard	Avoid contact	Disconnect battery	Wind speed	Machine not level
				
Manual force	No smoking. No flame. Stop engine.	Explosion hazard	Burn hazard	Explosion hazard

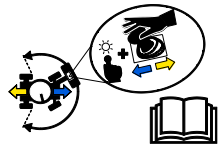
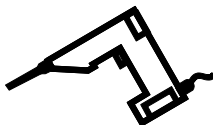
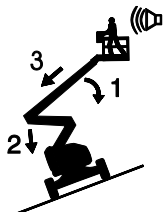
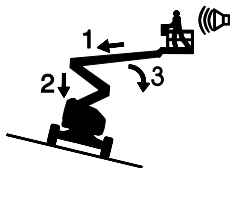
Symbol and Hazard Pictorials Definitions

 <p>Wheel load</p>	 <p>Tire specifications</p>	 <p>No smoking</p>	 <p>Explosion hazard</p>	 <p>Fire hazard</p>	
 <p>Platform tie-down instructions</p>	 <p>Lifting & tie down instructions</p>	 <p>Lanyard anchorage points</p>	 <p>Tie-down point</p>	 <p>Lifting point</p>	
 <p>Maximum capacity</p>	 <p>Runaway hazard</p>	 <p>Color coded direction arrows</p>	 <p>Voltage rating for power to platform</p>	 <p>Pressure rating for air line to platform</p>	
<p>Recovery procedure if tilt alarm sounds while elevated.</p> <div style="display: flex; justify-content: space-around;"> <div data-bbox="235 1186 397 1396">  <p>Platform uphill: 1 Lower primary. 2 Lower secondary. 3 Retract primary.</p> </div> <div data-bbox="454 1186 682 1396">  <p>Platform downhill: 1 Retract primary. 2 Lower secondary. 3 Lower primary.</p> </div> </div>		 <p>Access by trained and authorized personnel only</p>			

General Safety

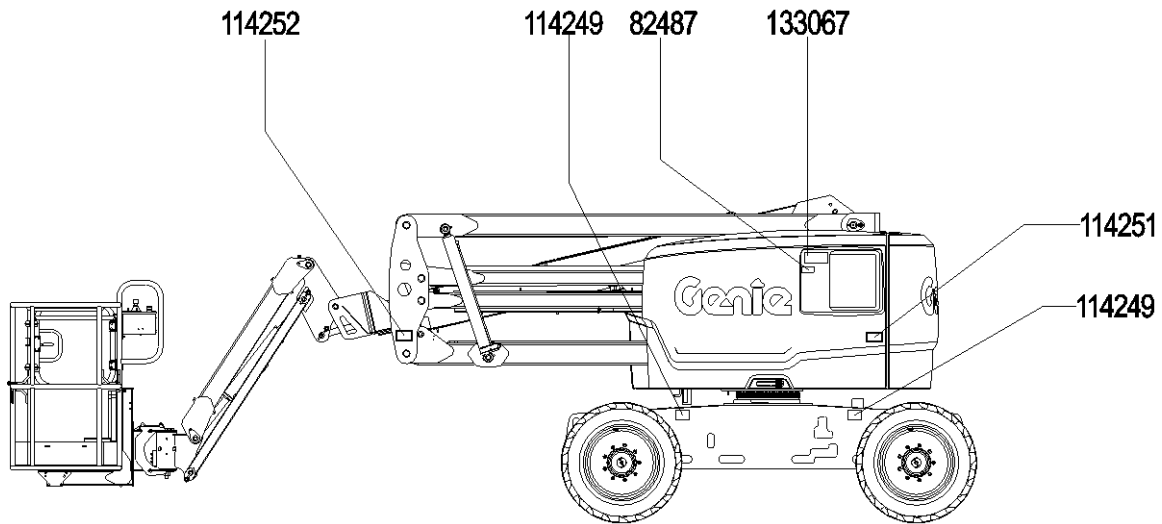

133067



114252

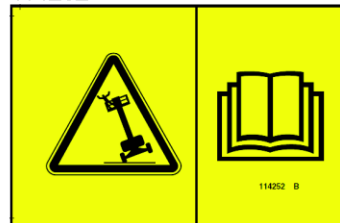

82487



114251



114249

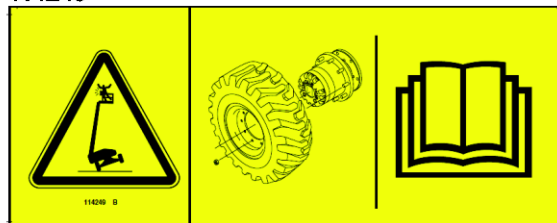

General Safety

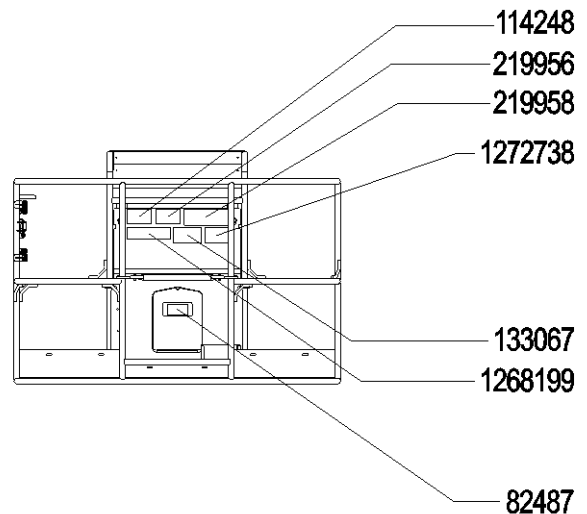
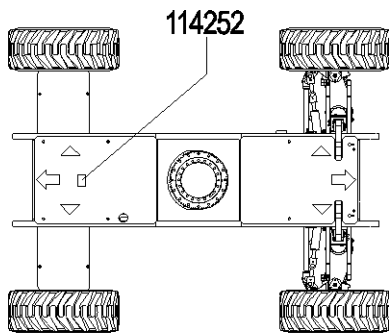

219958



133067



114248

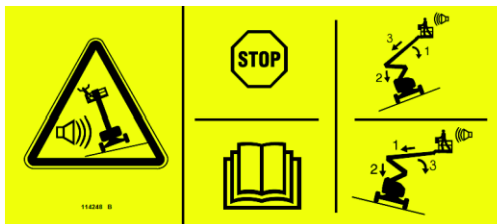

1268199

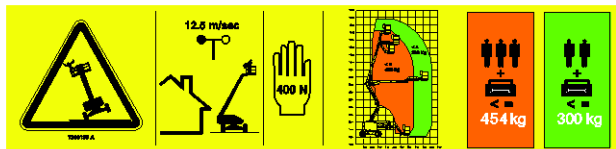

82487



114252



1272738



General Safety

114252

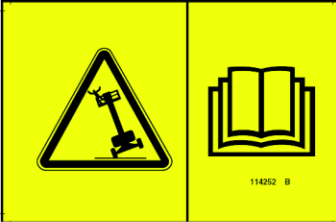

133067



1263542

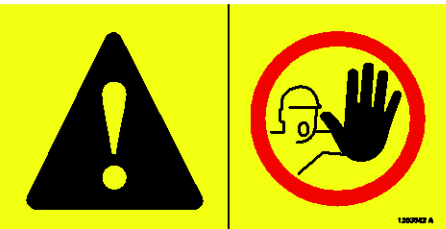

114249

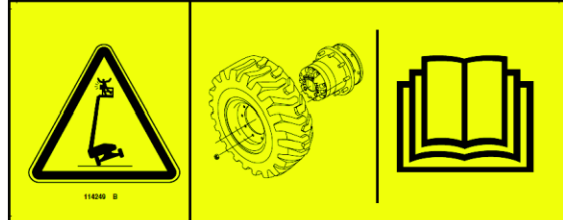

82481



133067

114252

1263542

82481

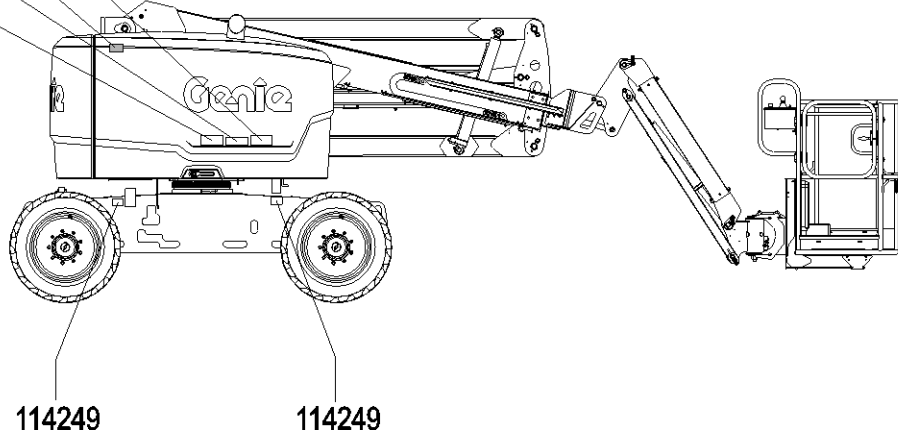

Personal Safety

Personal Fall Protection

Personal fall protection equipment (PFPE) is required when operating this machine.

Occupants must wear a safety belt or harness in accordance with governmental regulations. Attach the lanyard to the anchor provided in the platform.

Operators must comply with employer, job site and governmental rules regarding the use of personal protective equipment.

All PFPE must comply with applicable governmental regulations, and must be inspected and used in accordance with the PFPE manufacturer's instructions.

Work Area Safety

⚠ Electrocuting Hazards

This machine is not electrically insulated and will not provide protection from contact with or proximity to electrical current.

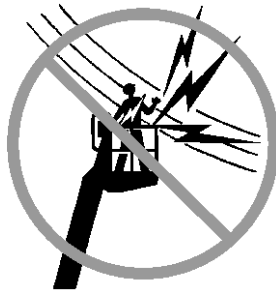

Obey all local and governmental regulations regarding required clearance from electrical power lines. At a minimum, the required clearance contained in the chart below must be followed.

Line Voltage	Required Clearance
0 to 50KV	3.05 m
50 to 200KV	4.60 m
200 to 350KV	6.10 m
350 to 500KV	7.62 m
500 to 750KV	10.67 m
750 to 1000KV	13.72 m

Allow for platform movement, electrical line sway or sag, and beware of strong or gusty winds.

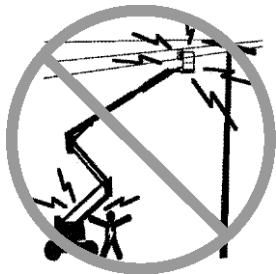

Keep away from the machine if it contacts energized power lines. Personnel on the ground or in the platform must not touch or operate the machine until energized power lines are shut off.

Do not operate the machine during lightning or storms.

Do not use the machine as a ground for welding.

⚠ Tip-over Hazards

Occupants, equipment and materials shall not exceed the maximum platform capacity.

Maximum platform capacity Unrestricted range of motion	300 kg
Maximum occupants	2
Maximum platform capacity Restricted range of motion	454 kg
Maximum occupants	3
Maximum platform capacity Unrestricted range of motion Machine equipped with Aircraft Protection Package	273 kg
Maximum occupants	2
Maximum platform capacity Restricted range of motion Machine equipped with Aircraft Protection Package	427 kg
Maximum occupants	3

If the platform load is greater than 301 kg, or 274 kg with Aircraft Protection Package do not move the platform into the unrestricted range of motion zone.

Do not exceed the maximum platform capacity.

Do not attach a platform rated at 300 kg (unrestricted range of motion) or 454 kg (restricted range of motion) to machines with any other rated load. See the serial label for the maximum rated load.

The weight of options and accessories, such as pipe cradles, panel cradles and welders, will reduce the rated platform capacity and must be subtracted from the platform capacity. See the decals with the options and accessories.

If using accessories, read, understand and obey the decals, instructions and manuals with the accessory.

Work Area Safety

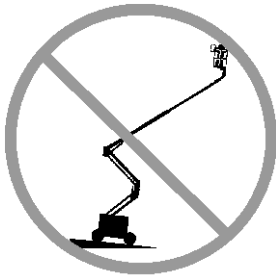

Do not raise or extend the boom unless the machine is on a firm, level surface.

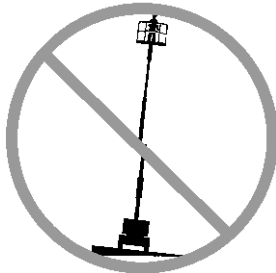

Do not depend on the tilt alarm as a level indicator. The tilt alarm sounds in the platform only when the machine is on a severe slope.

If the tilt alarm sounds when the platform is raised, use extreme caution. Identify the condition of the boom on the slope as shown in the tilt alarm procedure. Follow the steps to lower the boom before moving to a firm, level surface. Do not rotate the boom while lowering.

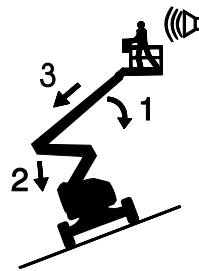

If the tilt alarm sounds with the platform uphill:

- 1 Lower the primary boom.
- 2 Lower the secondary boom.
- 3 Retract the primary boom.

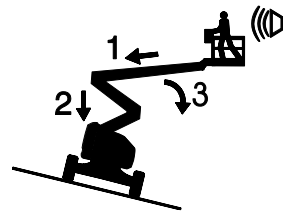

If the tilt alarm sounds with the platform downhill:

- 1 Retract the primary boom.
- 2 Lower the secondary boom.
- 3 Lower the primary boom.

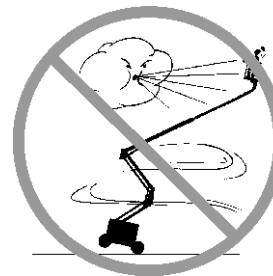

Do not raise the boom when wind speeds may exceed 12.5 m/s. If wind speeds exceed 12.5 m/s when the boom is raised, lower the boom and do not continue to operate the machine.

Do not operate the machine in strong or gusty winds. Do not increase the surface area of the platform or the load. Increasing the area exposed to the wind will decrease machine stability.

Work Area Safety

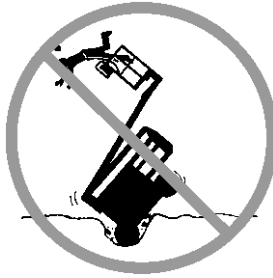

Use extreme care and slow speeds while driving the machine in the stowed position across uneven terrain, debris, unstable or slippery surfaces and near holes and drop-offs.

Do not drive the machine on or near uneven terrain, unstable surfaces or other hazardous conditions with the boom raised or extended.

Do not use the machine as a crane.

Do not push the machine or other objects with the boom.

Do not contact adjacent structures with the boom.

Do not tie the boom or platform to adjacent structures.

Do not place loads outside the platform perimeter.

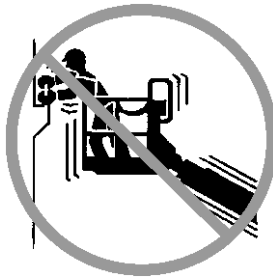

Do not push off or pull toward any object outside of the platform.

**Maximum allowable
manual force – CE**
400 N

Do not alter or disable machine components that in any way affect safety and stability.

Do not replace items critical to machine stability with items of different weight or specification.

Do not replace factory-installed tires with tires of different specification or ply rating.

Do not use air-filled tires. These machines are equipped with foam-filled tires. Wheel weight is critical to stability.

Do not use the platform controls to free a platform that is caught, snagged, or otherwise prevented from normal motion by an adjacent structure. All personnel must be removed from the platform before attempting to free the platform using the ground controls.

Do not modify or alter a mobile elevating work platform without prior written permission from the manufacturer. Mounting attachments for holding tools or other materials onto the platform, toeboards, or guard rail system can increase the weight in the platform and the surface area of the platform or the load.

Work Area Safety

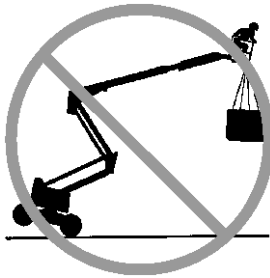

Do not place or attach fixed or overhanging loads to any part of this machine.



Do not place ladders or scaffolds in the platform or against any part of this machine.

Do not transport tools and materials unless they are evenly distributed and can be safely handled by person(s) in the platform.

Do not use the machine on a moving or mobile surface or vehicle.

Be sure all tires are in good condition, air-filled tires are properly inflated and lug nuts are properly tightened.

⚠ Operation on Slopes Hazards

Do not drive the machine on a slope that exceeds the maximum uphill, downhill or side slope rating of the machine. Slope rating applies only to machines in the stowed position.

Maximum slope rating, stowed position, 4WD

Platform downhill	45%	(24°)
Platform uphill	25%	(14°)
Side slope	25%	(14°)

Note: Slope rating is subject to ground conditions with one person in the platform and adequate traction. Additional platform weight may reduce slope rating. See Driving on a Slope in the Operating Instructions section.

Work Area Safety

▲ Fall Hazards

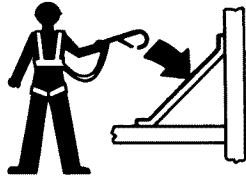

Occupants must wear a safety belt or harness in accordance with governmental regulations. Attach the lanyard to the anchor provided in the platform.



Do not sit, stand, or climb on the platform guard rails. Maintain a firm footing on the platform floor at all times.

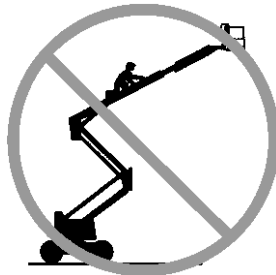

Do not climb down from the platform when raised.

Keep the platform floor clear of debris.

Lower the platform entry mid-rail or close the entry gate before operating.

Do not enter or exit the platform unless the machine is in the stowed position and the platform is at ground level.

Hazards related with the specific product application of exiting at height have been considered in the design of the machine, for further information contact Genie (see section Contacting the Manufacturer).

▲ Collision Hazards

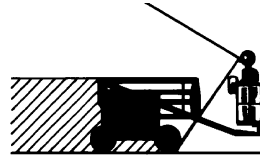

Be aware of limited sight distance and blind spots when driving or operating.

Be aware of the boom position and tailswing when rotating the turntable.



Check the work area for overhead obstructions or other possible hazards.

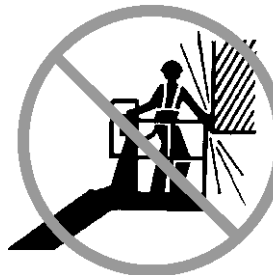

Be aware of crushing hazards when grasping the platform guard rail.

Operators must comply with employer, job site, and governmental rules regarding use of personal protective equipment.

Work Area Safety

Observe and use the color-coded direction arrows on the platform controls and drive chassis for drive and steer functions.



Do not lower the boom unless the area below is clear of personnel and obstructions.

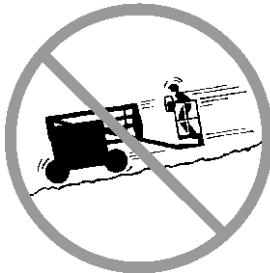

Limit travel speed according to the condition of the ground surface, congestion, slope, location of personnel, and any other factors which may cause collision.

Do not operate a boom in the path of any crane unless the controls of the crane have been locked out and/or precautions have been taken to prevent any potential collision.

No stunt driving or horseplay while operating a machine.

⚠ Bodily Injury Hazard

Always operate the machine in a well-ventilated area to avoid carbon monoxide poisoning.

Do not operate the machine with a hydraulic oil or air leak. An air leak or hydraulic leak can penetrate and/or burn skin.

Improper contact with components under any cover will cause serious injury. Only trained maintenance personnel should access compartments. Access by the operator is only advised when performing a pre-operation inspection. All compartments must remain closed and secured during operation.

⚠ Explosion and Fire Hazards

Do not start the engine if you smell or detect liquid petroleum gas (LPG), gasoline, diesel fuel or other explosive substances.

Do not refuel the machine with the engine running.

Refuel the machine and charge the battery only in an open, well-ventilated area away from sparks, flames and lighted tobacco.

Do not operate the machine or charge the battery in hazardous locations or locations where potentially flammable or explosive gases or particles may be present.

Do not spray ether into engines equipped with glow plugs.

Work Area Safety

⚠ Damaged Machine Hazards

Do not use a damaged or malfunctioning machine.

Conduct a thorough pre-operation inspection of the machine and test all functions before each work shift. Immediately tag and remove from service a damaged or malfunctioning machine.

Be sure all maintenance has been performed as specified in this manual and the appropriate Genie service manual.

Be sure all decals are in place and legible.

Be sure the operator's, safety, and responsibilities manuals are complete, legible, and in the storage container located on the machine.

⚠ Component Damage Hazards

Do not use any battery or charger greater than 12V to jump-start the engine.

Do not use the machine as a ground for welding.

Do not operate the machine in locations where extremely high magnetic fields may be present.

⚠ Battery Safety

Burn Hazards



Batteries contain acid. Always wear protective clothing and eye wear when working with batteries.

Avoid spilling or contacting battery acid. Neutralize battery acid spills with baking soda and water.

Explosion Hazards



Keep sparks, flames, and lighted tobacco away from batteries. Batteries emit explosive gas.

⚠ Electrocutation Hazard

Avoid contact with electrical terminals.

Work Area Safety

▲ Panel Cradle Safety

Read, understand and obey all warnings and instructions provided with the panel cradles.

Do not exceed the rated platform capacity. The combined weight of the cradles, panels, occupants, tools and any other equipment must not exceed rated capacity.

The panel cradle assembly weighs 13.6 kg.

The maximum capacity of the panel cradles is 113 kg.

The weight of the panel cradles and the load in the panel cradles may limit the maximum number of occupants in platform to one person.

Secure the cradles to the platform. Secure the panel (s) to the platform railing using the straps provided.

Do not operate unless you are adequately instructed and are aware of all hazards associated with lifting panels.

Do not cause a horizontal force or side load to machine by raising or lowering a fixed or overhanging load.

Maximum vertical height of panels: 1.2 m.

Maximum wind speed: 6.7 m/sec.

Maximum panel area: 3 m².

▲ Pipe Cradle Safety

Read, understand, and obey all warnings and instructions provided with the pipe cradles.

Do not exceed the rated platform capacity. The pipe cradle assembly and the weight in the pipe cradles will reduce rated platform capacity and must be factored into total platform load.

The pipe cradle assembly weighs 9.5 kg.

The maximum capacity of the pipe cradle assembly is 91 kg.

The weight of the pipe cradle assembly and the load in the pipe cradles may limit the maximum number of occupants in platform.

Center the load within the perimeter of the platform.

Secure the load to the platform.

Do not obstruct the entrance or the exit of the platform.

Do not obstruct the ability to operate the platform controls or the red Emergency Stop button.

Do not operate unless you are adequately instructed and are aware of all of the hazards associated with movement of the platform with an overhanging load.

Do not cause a horizontal force or side load to machine by raising or lowering a fixed or overhanging load.

Electrocution Hazard: Keep pipes away from all energized electrical conductors.

Work Area Safety

Lockout After Each Use

- 1 Select a safe parking location—firm level surface, clear of obstruction and traffic.
- 2 Retract and lower the boom to the stowed position.
- 3 Rotate the turntable so that the boom is between the non-steer wheels.
- 4 Turn the key switch to the off position and remove the key to secure from unauthorized use.

Legend

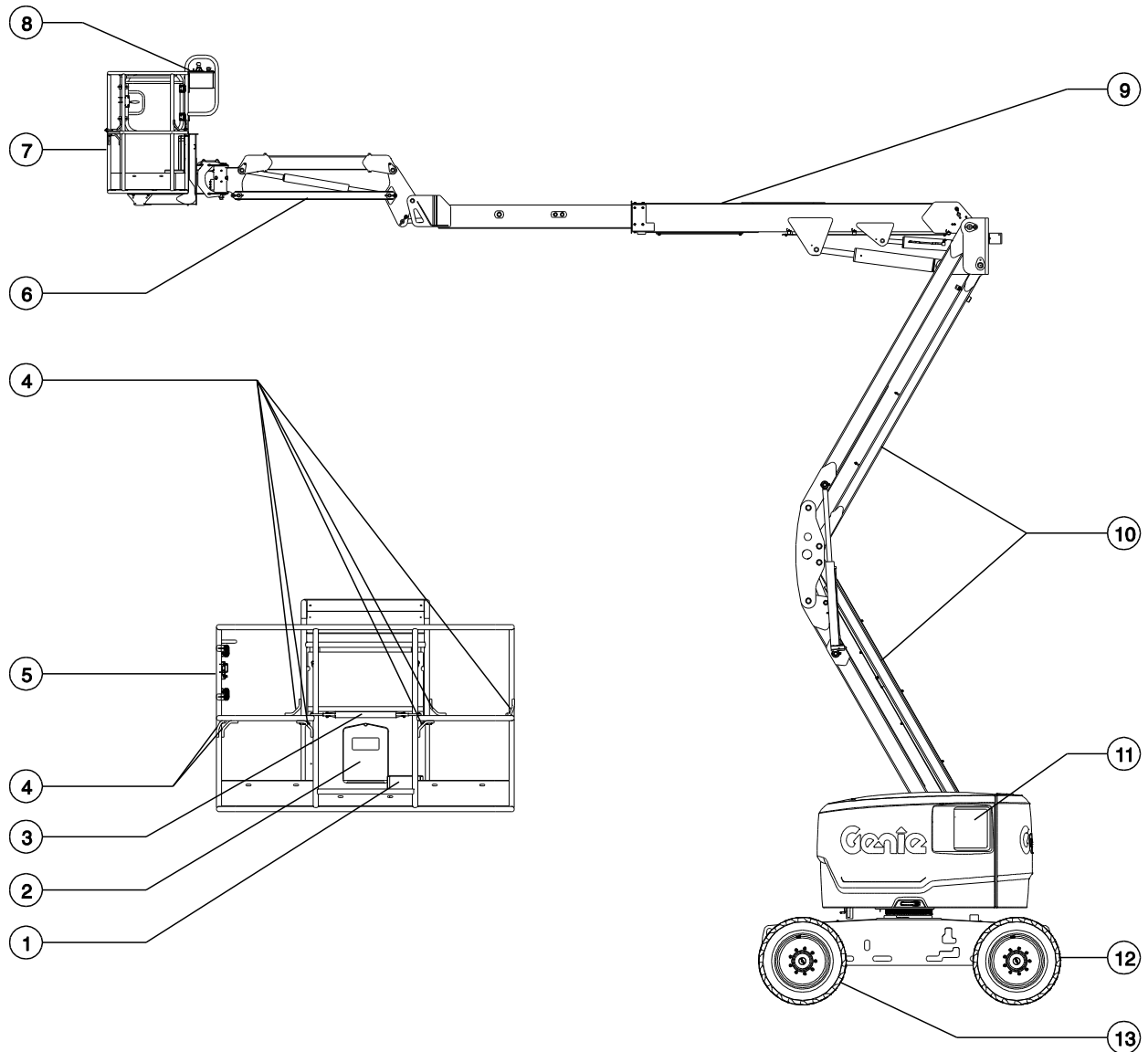

- 1 Foot switch
- 2 Manual storage container
- 3 Sliding mid-rail
- 4 Lanyard anchorage points
- 5 Swing gate
- 6 Jib boom
- 7 Platform

- 8 Platform controls
- 9 Primary boom
- 10 Secondary boom
- 11 Ground controls
- 12 Steer tire
- 13 Non-steer tire

Controls

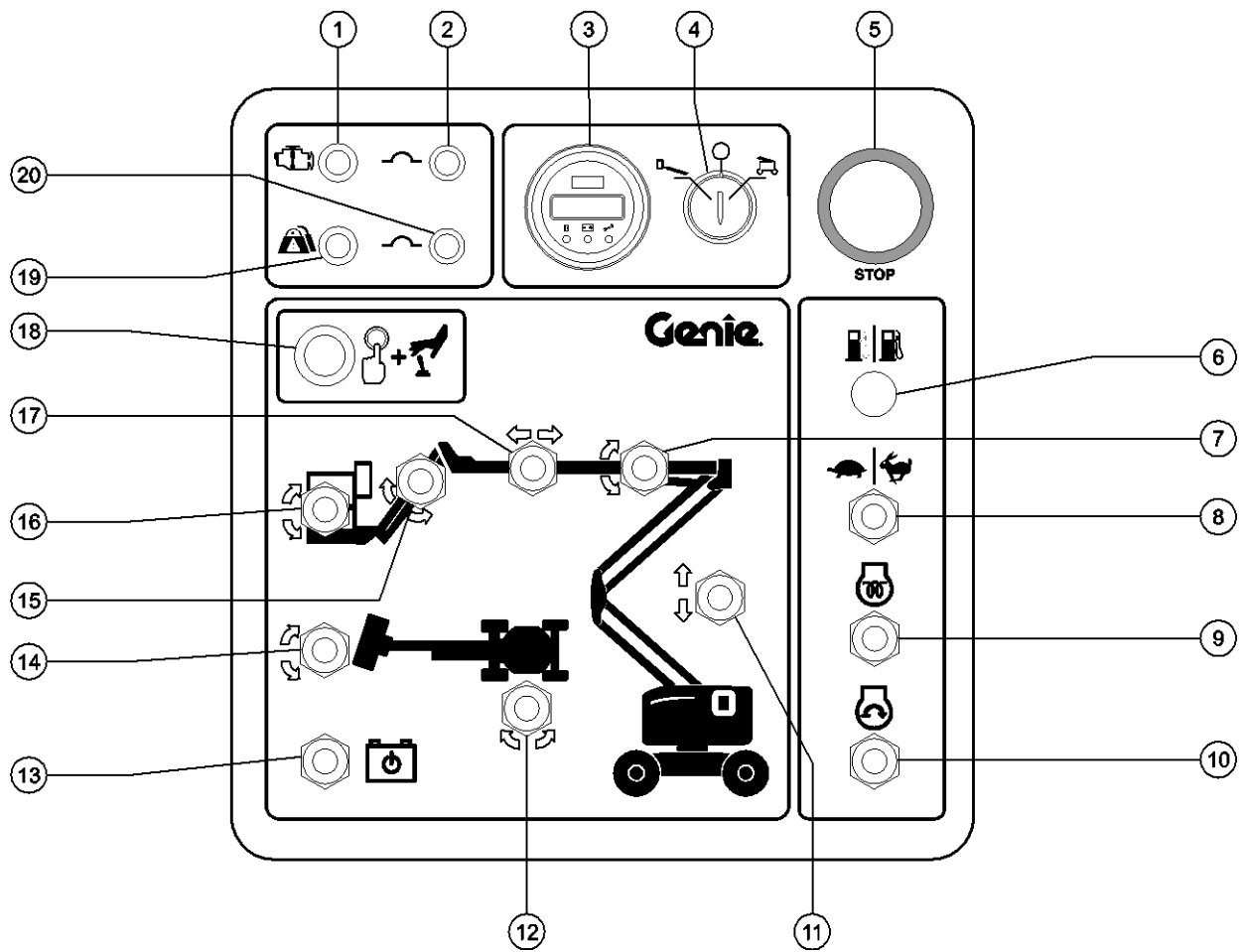

Ground Control Panel

Controls

Ground Control Panel

- 1 Diesel models: Oil pressure light
Light on and engine stopped: Tag the machine and remove from service.
Light on and engine still running: Contact service personnel within 24 hours.
- 2 15A breaker for engine electrical circuits
- 3 LCD display
At machine start up the LCD screen displays total hours the machine has operated, the battery charge level and the alarm beeps 4 seconds. The screen also displays fault codes and other service information.
- 4 Key switch for platform/off/ground selection
Turn the key switch to the platform position and the platform controls will operate. Turn the key switch to the off position and the machine will be off. Turn the key switch to the ground position and the ground controls will operate.
- 5 Red Emergency Stop button
Push in the red Emergency Stop button to the off position to stop all functions and turn the engine off. Pull out the red Emergency Stop button to the on position to operate the machine.
- 6 Not used
- 7 Primary boom up/down switch
Move the primary boom up/down switch up and the boom will raise. Move the primary boom up/down switch down and the boom will lower.
- 8 Engine idle (rpm) select switch
Move the engine idle select switch to the turtle position for foot switch activated low idle. Move the engine idle select switch to the rabbit position for foot switch activated high idle.
- 9 Diesel models: Glow plug switch (if equipped)
Move the glow plug switch to either side and hold for 3 to 5 seconds.
- 10 Engine start switch
Move the engine start switch to either side to start the engine.
- 11 Secondary boom up/down switch
Move the secondary boom up/down switch up and the secondary boom will raise. Move secondary boom up/down switch down and the secondary boom will lower.
- 12 Turntable rotate switch
Move the turntable rotate switch to the right and the turntable will rotate to the right. Move the turntable rotate switch to the left and the turntable will rotate to the left.
- 13 Emergency power switch
Use emergency power if the primary power source (engine) fails. Simultaneously hold the emergency power switch to either side and activate the desired function.

Controls

14 Platform rotate switch

Move the platform rotate switch to the right and the platform will rotate to the right. Move the platform rotate switch to the left and the platform will rotate to the left.

15 Jib boom up/down switch

Move the jib boom switch up and the jib boom will raise. Move the jib boom switch down and the jib boom will lower.

16 Platform level switch

Move the platform level switch up and the level of the platform will raise. Move the platform level switch down and the level of the platform will lower.

17 Primary boom extend/retract switch

Move the primary boom extend/retract switch to the right and the primary boom will retract. Move the boom extend/retract switch to the left and the primary boom will extend.

18 Function enable button

Press and hold the function enable button to enable the functions on the ground control panel to operate.

19 Platform overload indicator light

Light flashing indicates the platform is overloaded. The engine will stop and no functions will operate. Remove weight until the light goes off and then restart the engine.

20 15A breaker for control electrical circuits

Controls

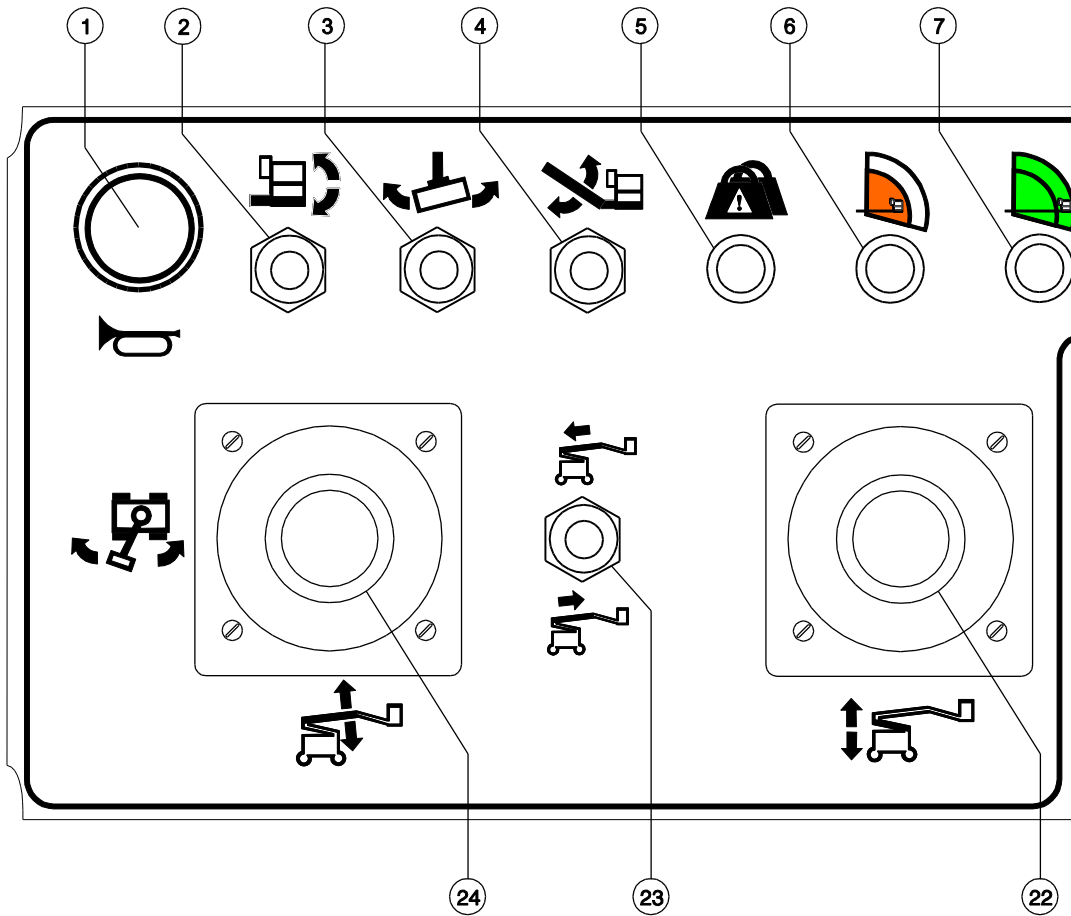

Platform Control Panel

Controls

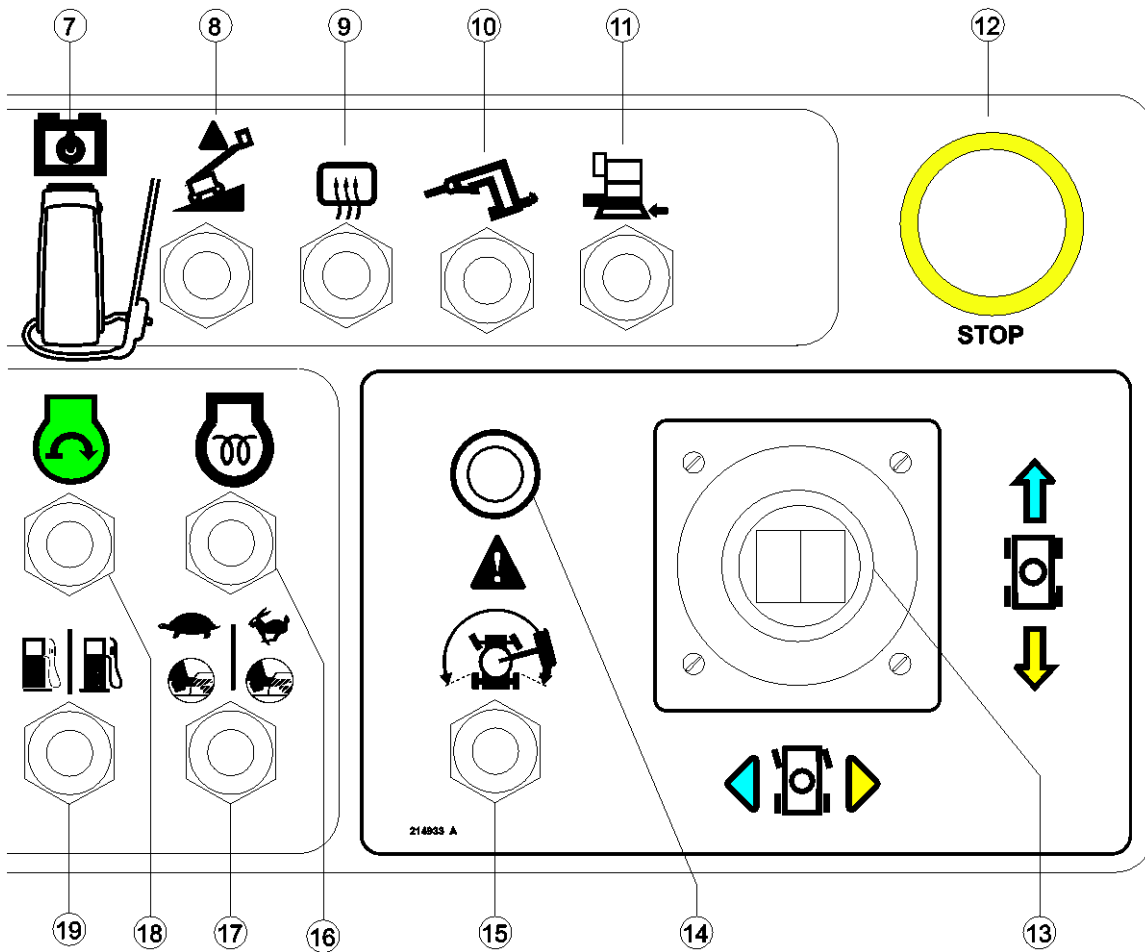

Controls

Platform Control Panel

1 Horn button

Press this button and the horn will sound. Release the button and the horn will stop.

2 Platform level switch

Move the platform level switch up and the level of the platform will raise. Move the platform level switch down and the level of the platform will lower.

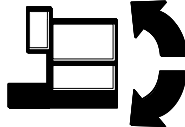

3 Platform rotate switch

Move the platform rotate switch to the right and the platform will rotate to the right. Move the platform rotate switch to the left and the platform will rotate to the left.

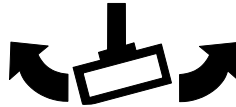

4 Jib boom up/down switch

Move the jib boom switch up and the jib boom will raise. Move the jib boom switch down and the jib boom will lower.

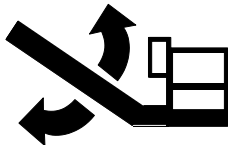

5 Platform overload indicator light

Light flashing indicates the platform is overloaded. The engine will stop and no functions will operate. Remove weight until the light goes off and then restart the engine.

6 Restricted range of motion indicator light

Light on indicates that the range of motion is restricted.

7 Unrestricted range of motion indicator light

Light on indicates that the range of motion is unrestricted.

8 Emergency lowering switch

Use emergency power if the primary power source (engine) fails. Simultaneously hold the emergency power switch to either side and activate the desired function.

9 Machine not level indicator light

The machine not level indicator light will come on when the tilt alarm sounds.

10 Generator switch (if equipped)

Move the generator switch up to activate the generator. Move the switch down to turn off the generator.

11 Aircraft protection override switch (if equipped)

Move and hold the aircraft protection override switch to operate the machine when the platform bumper is against an object.

Controls

- 12 Work light switch (if equipped)
Move the work light switch up to activate the lights. Move the work light switch down to turn off the lights.
- 13 Red Emergency Stop button
Push in the red Emergency Stop button to the off position to stop all functions and turn the engine off. Pull out the red Emergency Stop button to the on position to operate the machine.
- 14 Dual axis proportional control handle for drive and steer functions.
OR
Proportional control handle for drive function and thumb rocker for steer function.
Move the control handle in the direction indicated by the blue arrow on the control panel and the machine will drive forward. Move the control handle in the direction indicated by the yellow arrow and the machine will drive backwards. Move the control handle in the direction indicated by the blue triangle and the machine will steer to the left. Move the control handle in the direction indicated by the yellow triangle and the machine will steer to the right.
OR
Move the control handle in the direction indicated by the blue arrow on the control panel and the machine will drive forward. Move the control handle in the direction indicated by the yellow arrow and the machine will drive backwards. Press the left side of the thumb rocker and the machine will steer to the left. Press the right side of the thumb rocker and the machine will steer to the right.
- 15 Drive speed select switch
Machine on incline symbol: Low range operation for inclines.
Machine on level surface symbol: High range operation for maximum drive speed.
- 16 Drive enable switch
To drive when the drive enable light is on, hold the drive enable switch to either side and slowly move the drive control handle off center. Be aware that the machine may move in the opposite direction that the drive and steer controls are moved.
- 17 Drive enable indicator light
Light on indicates that the boom has moved just past either non-steer wheel and drive function has been interrupted.
- 18 Glow plug switch
Move the glow plug switch to either side and hold for 3 to 5 seconds.
- 19 Engine idle (rpm) select switch
Move the engine idle select switch to the turtle position for foot switch activated low idle. Move the engine idle select switch to the rabbit position for foot switch activated high idle.
- 20 Engine start switch
Move the engine start switch to either side to start the engine.
- 21 Models with LCD screen: Engine shut-down indicator light
Light on indicates that the engine has shut down. Contact service personnel.

Controls

- 22 Proportional control handle for secondary boom up/down function

Move the control handle up and the secondary boom will raise. Move the control handle down and the secondary boom will lower.



- 23 Primary boom extend/retract switch

Move the primary boom extend/retract switch up and the primary boom will retract. Move the boom extend/retract switch down and the primary boom will extend.



- 24 Dual axis proportional control handle for primary boom up/down and turntable rotate left/right functions

Move the control handle up and the primary boom will raise. Move the control handle down and the primary boom will lower.

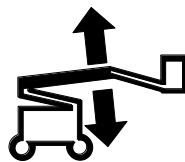

Move the control handle to the right and the turntable will rotate to the right. Move the control handle to the left and the turntable will rotate to the left.



Inspections



Do Not Operate Unless:

- You learn and practice the principles of safe machine operation contained in this operator's manual.
 - 1 Avoid hazardous situations.
 - 2 Always perform a pre-operation inspection.**
 - Know and understand the pre-operation inspection before going on to the next section.**
 - 3 Always perform function tests prior to use.
 - 4 Inspect the workplace.
 - 5 Only use the machine as it was intended.

Pre-operation Inspection Fundamentals

It is the responsibility of the operator to perform a pre-operation inspection and routine maintenance.

The pre-operation inspection is a visual inspection performed by the operator prior to each work shift. The inspection is designed to discover if anything is apparently wrong with a machine before the operator performs the function tests.

The pre-operation inspection also serves to determine if routine maintenance procedures are required. Only routine maintenance items specified in this manual may be performed by the operator.

Refer to the list on the next page and check each of the items.

If damage or any unauthorized variation from factory delivered condition is discovered, the machine must be tagged and removed from service.

Repairs to the machine may only be made by a qualified service technician, according to the manufacturer's specifications. After repairs are completed, the operator must perform a pre-operation inspection again before going on to the function tests.

Scheduled maintenance inspections shall be performed by qualified service technicians, according to the manufacturer's specifications and the requirements listed in the responsibilities manual.

Inspections

Pre-operation Inspection

- Be sure that the operator's, safety, and responsibilities manuals are complete, legible and in the storage container located in the platform.
- Be sure that all decals are legible and in place. See Inspections section.
- Check for hydraulic oil leaks and proper oil level. Add oil if needed. See Maintenance section.
- Check for battery fluid leaks and proper fluid level. Add distilled water if needed. See Maintenance section.
- Check for engine oil leaks and proper oil level. Add oil if needed. See Maintenance section.
- Check for engine coolant leaks and proper level of coolant. Add coolant if needed. See Maintenance section.

Check the following components or areas for damage, improperly installed, or missing parts and unauthorized modifications:

- Electrical components, wiring, and electrical cables
- Hydraulic hoses, fittings, cylinders, and manifolds
- Fuel and hydraulic tanks
- Drive and turntable motors and drive hubs
- Wear pads
- Tires and wheels
- Engine and related components
- Limit switches and horn

- Alarms and beacons (if equipped)
- Nuts, bolts and other fasteners
- Platform entry mid-rail or gate
- Platform load cell
- Lanyard anchorage points

Check entire machine for:

- Cracks in welds or structural components
- Dents or damage to machine
- Excessive rust, corrosion or oxidation
- Verify that all structural and other critical components are present and all associated fasteners and pins are in place and properly tightened.
- After you complete your inspection, be sure that all compartment covers are in place and latched.

Inspections



Do Not Operate Unless:

- You learn and practice the principles of safe machine operation contained in this operator's manual.
 - 1 Avoid hazardous situations.
 - 2 Always perform a pre-operation inspection.
 - 3 Always perform function tests prior to use.**

Know and understand the function tests before going on to the next section.

- 4 Inspect the workplace.
- 5 Only use the machine as it was intended.

Function Test Fundamentals

The function tests are designed to discover any malfunctions before the machine is put into service. The operator must follow the step-by-step instructions to test all machine functions.

A malfunctioning machine must never be used. If malfunctions are discovered, the machine must be tagged and removed from service. Repairs to the machine may only be made by a qualified service technician, according to the manufacturer's specifications.

After repairs are completed, the operator must perform a pre-operation inspection and function tests again before putting the machine into service.

Inspections

At the Ground Controls

- 1 Select a test area that is firm, level and free of hazards.
- 2 Turn the key switch to ground control.
- 3 Pull out the red Emergency Stop button to the on position.
- ⦿ Result: The beacon (if equipped) should flash.
- 4 Start the engine. See Operating Instructions section.

Test Emergency Stop

- 5 Push in the red Emergency Stop button to the off position.
- ⦿ Result: The engine will shut off after 2 to 3 seconds.
- 6 Pull out the red Emergency Stop button to the on position and restart the engine.

Test Machine Functions

- 7 Do not push and hold the function enable button. Attempt to activate each boom and platform function toggle switch.
- ⦿ Result: No boom and platform functions should operate.
- 8 Press and hold the function enable button and activate each boom and platform function toggle switch.
- ⦿ Result: All boom and platform functions should operate through a full cycle. The descent alarm should sound while the boom is lowering.

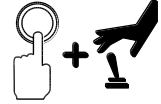

Inspections

Test the Tilt Sensor

- 9 Turn the key switch to platform control. Pull out the platform red Emergency Stop button to the on position.
- 10 Open the engine side turntable cover and locate the tilt sensor to the right of the hydraulic pump.
- 11 Press down one side of the tilt sensor.
- ⊙ Result: The alarm, located in the platform, should sound.

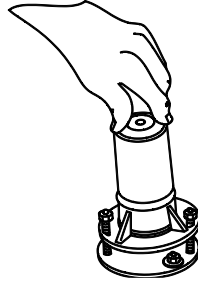

Test Emergency Controls

- 12 Turn the key switch to ground control and shut the engine off.
- 13 Pull out the red Emergency Stop button to the on position.
- 14 Simultaneously hold the emergency power switch on and activate each boom function toggle switch.

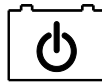

Note: To conserve battery power, test each function through a partial cycle.

- ⊙ Result: All boom functions should operate.

At the Platform Controls

Test Emergency Stop

- 15 Turn the key switch to platform control and restart the engine.
- 16 Push in the platform red Emergency Stop button to the off position.
- ⊙ Result: The engine will shut off after 2 to 3 seconds.
- 17 Pull out the red Emergency Stop button and restart the engine.

Test the Horn

- 18 Press the horn button.
- ⊙ Result: The horn should sound.

Test the Foot Switch

- 19 Push in the platform red Emergency Stop button to the off position.
- 20 Pull out the red Emergency Stop button to the on position and do not start the engine.
- 21 Press down the foot switch and attempt to start the engine by moving the start toggle switch to either side.
- ⊙ Result: The engine should not start.
- 22 Do not press down the foot switch and restart the engine.
- ⊙ Result: The engine should start.
- 23 Do not press down the foot switch and test each machine function.
- ⊙ Result: No functions should operate.

Inspections

Test Machine Functions

- 24 Press down the foot switch.
 - 25 Activate each machine function control handle or toggle switch.
- ⦿ Result: All boom and platform functions should operate through a full cycle.

Test the Steering

- 26 Press down the foot switch.
 - 27 Press the thumb rocker switch on top of the drive control handle in the direction indicated by the blue triangle on the control panel OR slowly move the control handle in the direction indicated by the blue triangle.
- ⦿ Result: The steer wheels should turn in the direction that the blue triangles point on the drive chassis.
- 28 Press the thumb rocker switch in the direction indicated by the yellow triangle on the control panel OR slowly move the control handle in the direction indicated by the yellow triangle.
- ⦿ Result: The steer wheels should turn in the direction that the yellow triangles point on the drive chassis.

Test Drive and Braking

- 29 Press down the foot switch.
 - 30 Slowly move the drive control handle in the direction indicated by the blue arrow on the control panel until the machine begins to move, then return the handle to the center position.
- ⦿ Result: The machine should move in the direction that the blue arrow points on the drive chassis, then come to an abrupt stop.
- 31 Slowly move the control handle in the direction indicated by the yellow arrow on the control panel until the machine begins to move, then return the handle to the center position.
- ⦿ Result: The machine should move in the direction that the yellow arrow points on the drive chassis, then come to an abrupt stop.

Note: The brakes must be able to hold the machine on any slope it is able to climb.

Inspections

Test the Drive Enable System

- 32 Press down the foot switch and lower the boom to the stowed position.
- 33 Rotate the turntable until the primary boom moves past one of the non-steer wheels.

- ⊙ Result: The drive enable indicator light should come on and remain on while the boom is anywhere in the range shown.

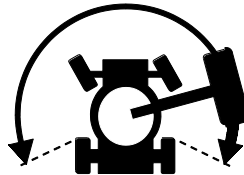

- 34 Move the drive control handle off center.
- ⊙ Result: The drive function should not operate.
- 35 Move and hold the drive enable toggle switch to either side and slowly move the drive control handle off center.
- ⊙ Result: The drive function should operate.

Note: When the drive enable system is in use, the machine may drive in the opposite direction that the drive and steer control handle is moved.

Use the color-coded direction arrows on the platform controls and the drive chassis to identify the direction of travel.

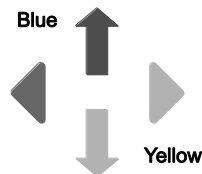

Test Limited Drive Speed

- 36 Press down the foot switch.
- 37 Raise the primary boom approximately 61 cm.
- 38 Slowly move the drive control handle to the full drive position.
- ⊙ Result: The maximum achievable drive speed with the primary boom raised should not exceed 30 cm/s.
- 39 Lower the primary boom to the stowed position.
- 40 Raise the secondary boom approximately 61 cm.
- 41 Slowly move the drive control handle to the full drive position.
- ⊙ Result: The maximum achievable drive speed with the secondary boom raised should not exceed 30 cm/s.
- 42 Lower the secondary boom to the stowed position.
- 43 Extend the primary boom approximately 30 cm.
- 44 Slowly move the drive control handle to the full drive position.
- ⊙ Result: The maximum achievable drive speed with the primary boom extended should not exceed 30 cm/s.
- 45 Retract the boom to the stowed position.

If the drive speed with the primary boom raised, the secondary boom raised or the primary boom extended exceeds 30 cm/s, immediately tag and remove the machine from service.

Inspections

Test Drive Tilt Cutout

- 46 Press down the foot switch.
- 47 With the boom fully stowed, drive the machine onto a slope where the chassis pitch angle is greater than 2.5°.
 - ⊙ Result: The machine should continue to drive.
- 48 Return to level ground and raise the primary boom to an out of stowed position (approximately 10° above horizontal).
- 49 Drive the machine onto a slope where the chassis pitch angle is greater than 2.5°.
 - ⊙ Result: The machine should stop once the machine reaches 2.5° of chassis tilt and the alarm should sound at the platform controls.
- 50 Lower the primary boom to the stowed position or drive in the opposite direction.
 - ⊙ Result: The machine should drive.
- 51 Return to level ground and extend the primary boom approximately 0.5 m.
- 52 Drive the machine onto a slope where the chassis pitch angle is greater than 2.5°.
 - ⊙ Result: The machine should stop once the machine reaches 2.5° of chassis tilt and the alarm should sound at the platform controls.
- 53 Retract the primary boom to the stowed position or drive in the opposite direction.
 - ⊙ Result: The machine should drive.
- 54 Return to level ground and stow the boom.
- 55 With the boom fully stowed, drive the machine onto a slope where the chassis pitch angle is greater than 2.5°.
 - ⊙ Result: The machine should continue to drive.
- 56 Return to level ground and raise the secondary boom to an out of stowed position (approximately 15° above horizontal).
- 57 Drive the machine onto a slope where the chassis pitch angle is greater than 2.5°.
 - ⊙ Result: The machine should stop once the machine reaches 2.5° of chassis tilt and the alarm should sound at the platform controls.
- 58 Lower the secondary boom to the stowed position or drive in the opposite direction.
 - ⊙ Result: The machine should drive.
- 59 With the boom fully stowed, drive the machine onto a slope where the chassis pitch angle is greater than 2.5°.
 - ⊙ Result: The machine should continue to drive.
- 60 Return to level ground and raise the primary boom to an out of stowed position (approximately 10° above horizontal).
- 61 Drive the machine onto a slope where the chassis roll angle is greater than 2.5°.
 - ⊙ Result: The machine should stop once the machine reaches 2.5° of chassis tilt and the alarm should sound at the platform controls.

Inspections

62 Lower the primary boom to the stowed position or drive in the opposite direction.

⦿ Result: The machine should drive.

63 Return to level ground and extend the primary boom approximately 0.5 m.

64 Drive the machine onto a slope where the chassis roll angle is greater than 2.5°.

⦿ Result: The machine should stop once the machine reaches 2.5° of chassis tilt and the alarm should sound at the platform controls.

65 Retract the primary boom to the stowed position or drive in the opposite direction.

⦿ Result: The machine should drive.

66 Return to level ground and stow the boom.

67 With the boom fully stowed, drive the machine onto a slope where the chassis roll angle is greater than 2.5°.

⦿ Result: The machine should continue to drive.

68 Return to level ground and raise the secondary boom to an out of stowed position (approximately 15° above horizontal).

69 Drive the machine onto a slope where the chassis roll angle is greater than 2.5°.

⦿ Result: The machine should stop once the machine reaches 2.5° of chassis tilt and the alarm should sound at the platform controls.

70 Lower the secondary boom to the stowed position or drive in the opposite direction.

⦿ Result: The machine should drive.

Test the Oscillating Axle (if equipped)

71 Start the engine from the platform controls.

72 Drive the right steer tire up onto a 15 cm block or curb.

⦿ Result: The three remaining tires should stay in firm contact with the ground.

73 Drive the left steer tire up onto a 15 cm block or curb.

⦿ Result: The three remaining tires should stay in firm contact with the ground.

74 Drive both steer tires up onto a 15 cm block or curb.

⦿ Result: The non-steer tires should stay in firm contact with the ground.

Test the Lift/Drive Select Function

75 Press down the foot switch.

76 Move the drive control handle off center and activate a boom function toggle switch.

⦿ Result: No boom functions should operate. The machine will move in the direction indicated on the control panel.

Repair any malfunctions before operating the machine.

Inspections

Test Aircraft Protection Package (if equipped)

Note: Two people may be required to perform this test.

- 77 Extend the primary boom approximately 30 cm.
- 78 Move the yellow bumper at the bottom of the platform 10 cm in any direction.
- 79 Activate each function control handle or toggle switch.
- ⦿ Result: No boom and steer functions should operate.
- 80 Move and hold the aircraft protection override switch.

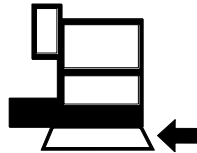

- 81 Activate each function control handle or toggle switch.
- ⦿ Result: All boom and steer functions should operate.

Inspections



Do Not Operate Unless:

- You learn and practice the principles of safe machine operation contained in this operator's manual.
 - 1 Avoid hazardous situations.
 - 2 Always perform a pre-operation inspection.
 - 3 Always perform function tests prior to use.
 - 4 Inspect the workplace.**

Know and understand the workplace inspection before going on to the next section.
 - 5 Only use the machine as it was intended.

Workplace Inspection Fundamentals

The workplace inspection helps the operator determine if the workplace is suitable for safe machine operation. It should be performed by the operator prior to moving the machine to the workplace.

It is the operator's responsibility to read and remember the workplace hazards, then watch for and avoid them while moving, setting up, and operating the machine.

Workplace Inspection Checklist

Be aware of and avoid the following hazardous situations:

- drop-offs or holes
- bumps, floor obstructions, or debris
- sloped surfaces
- unstable or slippery surfaces
- overhead obstructions and high voltage conductors
- hazardous locations
- inadequate surface support to withstand all load forces imposed by the machine
- wind and weather conditions
- the presence of unauthorized personnel
- other possible unsafe conditions

Inspections

Decal Inspection

Use the pictures on the next page to verify that all decals are legible and in place.

Below is a numerical list with quantities and descriptions.

Part No.	Decal Description	Qty
27204	Arrow – Blue	1
27205	Arrow – Yellow	1
27206	Triangle – Blue	2
27207	Triangle – Yellow	2
28159	Label – Diesel	1
28174	Label – Power to Platform, 230V	2
28235	Label – Power to Platform, 115V	2
40434	Label – Lanyard Anchorage Point	8
44981	Label – Air Line to Platform (option)	2
52475	Label – Transport Tie-down	4
52969	Cosmetic – Genie Boom	1
62948	Cosmetic – IC Power 4 x 4	1
72086	Label – Lifting Point	4
82240	Label – 105 dB	1
82481	Label – Battery/Charger Safety	1
82487	Label – Read the Manual	2
97815	Label – Lower Mid-rail	1
114248	Label – Tip-over Hazard, Tilt Alarm	1

Part No.	Decal Description	Qty
114249	Label – Tip-over Hazard, Tires	4
114251	Label – Explosion Hazard	1
114252	Label – Tip-over Hazard, Limit Switches	3
133067	Label – Electrocutation Hazard	3
214932	Ground Control Panel	1
219952	Label – Emergency Lowering	1
219956	Label – Platform Overload	1
219958	Label – Tip-over, Crush Hazard	1
1255581	Cosmetic – Genie	2
1255582	Cosmetic – Genie	1
1263542	Label – Compartment Access	1
1268192	Label – Wheel Load	4
1268195	Cosmetic – Z-45 XC	1
1268199	Label – Tip-over Hazard	1
1268200	Label – Transport and Lifting Instructions	2
1272242	Label – Machine Registration/Owner Transfer	1
1272738	Label – Slope Rating	1
1274536	Platform Control Panel, Z-45 XC	1
1278357	Label – Load Sense Calibration	1

 Shading indicates decal is hidden from view, i.e. under covers

* These decals are model, option or configuration specific.

Inspections

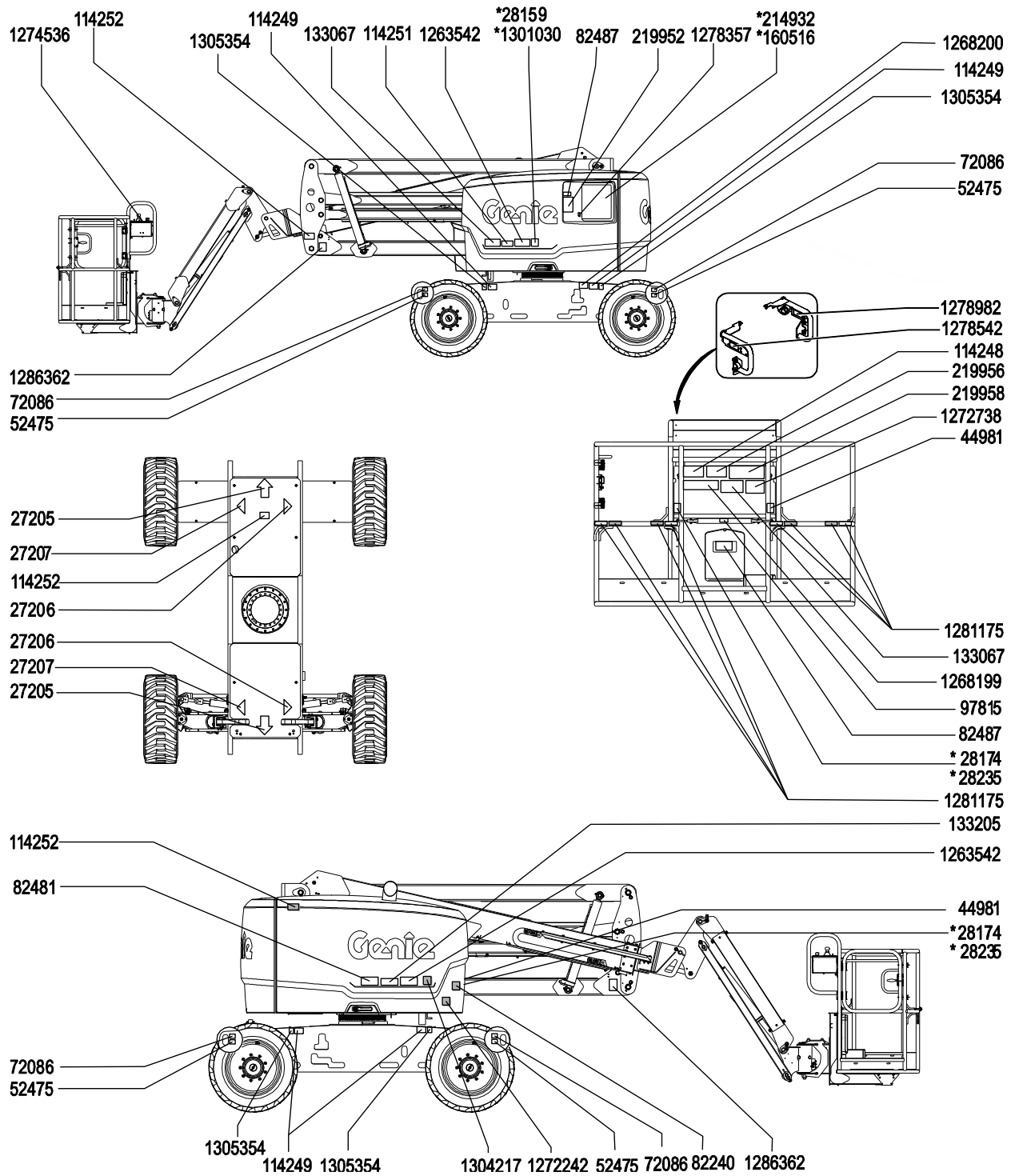

Operating Instructions



Do Not Operate Unless:

- You learn and practice the principles of safe machine operation contained in this operator's manual.
 - 1 Avoid hazardous situations.
 - 2 Always perform a pre-operation inspection.
 - 3 Always perform function tests prior to use.
 - 4 Inspect the workplace.
 - 5 **Only use the machine as it was intended.**

Fundamentals

The Operating Instructions section provides instructions for each aspect of machine operation. It is the operator's responsibility to follow all the safety rules and instructions in the operator's, safety, and responsibilities manuals.

Using the machine for anything other than lifting personnel, along with their tools and materials, to an aerial work site is unsafe and dangerous.

Only trained and authorized personnel should be permitted to operate a machine. If more than one operator is expected to use a machine at different times in the same work shift, they must all be qualified operators and are all expected to follow all safety rules and instructions in the operator's, safety, and responsibilities manuals. That means every new operator should perform a pre-operation inspection, function tests, and a workplace inspection before using the machine.

Operating Instructions

Starting the Engine

- 1 At the ground controls, turn the key switch to the desired position.
- 2 Be sure both ground and platform control red Emergency Stop buttons are pulled out to the on position.

Diesel models

- 1 Move the glow plug switch to either side and hold for 3 to 5 seconds.
- 2 Move the engine start toggle switch to either side. If the engine fails to start or dies, the restart delay will disable the start switch for 3 seconds.

All models

If the engine fails to start after 15 seconds of cranking, determine the cause and repair any malfunction. Wait 60 seconds before trying to start again.

In cold conditions, -6°C and below, warm the engine for 5 minutes before operating to prevent hydraulic system damage.

In extreme cold conditions, -18°C and below, machines should be equipped with optional cold start kits. Attempting to start the engine when temperatures are below -18°C may require the use of a booster battery.

Emergency Stop

Push in the red Emergency Stop button to the off position at the ground controls or the platform controls to stop all machine functions and turn the engine off.

Repair any function that operates when either red Emergency Stop button is pushed in.

Selecting and operating the ground controls will override the platform red Emergency Stop button.

Emergency Power

Use emergency power if the primary power source (engine) fails.

- 1 Turn the key switch to ground or platform control.
- 2 Pull out the red Emergency Stop button to the on position.
- 3 Press down the foot switch when using the controls from the platform.
- 4 Break the security tie and lift the emergency power switch cover.

Note: If the security tie is broken or missing, consult the appropriate Genie Service Manual.

- 5 Simultaneously hold the emergency power switch on and activate the desired function.

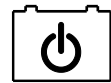

The drive function will not operate with emergency power.

Operating Instructions

Operation from Ground

- 1 Turn the key switch to ground control.
- 2 Pull out the red Emergency Stop button to the on position.
- 3 Gasoline/LPG models: Choose fuel by moving the fuel select switch to the desired position.
- 4 Start the engine.

To Position Platform

- 1 Push and hold the function enable button.



- 2 Move the appropriate toggle switch according to the markings on the control panel.

Drive and steer functions are not available from the ground controls.

Operation from Platform

- 1 Turn the key switch to platform control.
- 2 Pull out both ground and platform red Emergency Stop buttons to the on position.
- 3 Gasoline/LPG models: Choose fuel by moving the fuel select switch to the desired position.
- 4 Start the engine. Do not press down the foot switch when starting the engine.

To Position Platform

- 1 Press down the foot switch.
- 2 Slowly move the appropriate function control handle or toggle switch or press the appropriate button according to the markings on the control panel.

To Steer

- 1 Press down the foot switch.
- 2 Slowly move the drive control handle in the direction indicated by blue or yellow triangles OR press the thumb rocker switch located on top of the drive control handle.

Use the color-coded direction arrows on the platform controls and the drive chassis to identify the direction the wheels will turn.

To Drive

- 1 Press down the foot switch.
- 2 Increase speed: Slowly move the control handle off center.

Decrease speed: Slowly move the control handle toward center.

Stop: Return the control handle to center or release the function enable switch.

Use the color-coded direction arrows on the platform controls and the drive chassis to identify the direction the machine will travel.

Machine travel speed is restricted when the boom is raised.

Operating Instructions

▲ Driving on a slope

Determine the uphill, downhill and side slope ratings for the machine and determine the slope grade.



Maximum slope rating, platform downhill (gradeability):

4WD: 45% (24°)



Maximum slope rating, platform uphill:

25% (14°)



Maximum side slope rating:

25% (14°)

Note: Slope rating is subject to ground conditions with one person in the platform and adequate traction. Additional platform weight may reduce slope rating. The term gradeability applies to the counterweight uphill configuration only.

Be sure the boom is below horizontal and the platform is between the circle-end wheels.

Move the drive speed select switch to machine on incline symbol.

To determine the slope grade:

Measure the slope with a digital inclinometer OR use the following procedure.

You will need:

- carpenter's level
- straight piece of wood, at least 1 m long
- tape measure

Lay the piece of wood on the slope.

At the downhill end, lay the level on the top edge of the piece of wood and lift the end until the piece of wood is level.

While holding the piece of wood level, measure the vertical distance from the bottom of the piece of wood to the ground.

Divide the tape measure distance (rise) by the length of the piece of wood (run) and multiply by 100.

Example:

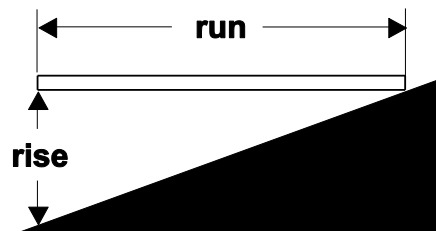

Piece of wood = 3.6 m

Run = 3.6 m

Rise = 0.3 m

$0.3 \text{ m} \div 3.6 \text{ m} = 0.083 \times 100 = 8.3\% \text{ grade}$

If the slope exceeds the maximum uphill, downhill or side slope rating, then the machine must be winched or transported up or down the slope. See Transport and Lifting section.

Operating Instructions

Drive Enable

Light on indicates that the boom has moved just past either non-steer wheel and the drive function has been interrupted.



To drive, hold the drive enable switch to either side and slowly move the drive control handle off center.

Be aware that the machine may move in the opposite direction that the drive and steer controls are moved.

Always use the color-coded direction arrows on the platform controls and the drive chassis to identify the direction the machine will travel.

Drive Speed Select



- Machine on incline symbol: Low range operation for inclines
- Machine on level surface symbol: High range operation for maximum drive speed

Engine Idle Select (rpm)

To select engine idle (rpm), move the switch to the turtle symbol or the rabbit symbol.

When the foot switch is not pressed, the engine will idle at the lowest rpm.

- Turtle symbol: Foot switch activated low idle
- Rabbit symbol: Foot switch activated high idle



Generator (if equipped)

To start the generator, move the generator toggle switch to the on position.

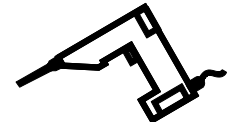

Plug a power tool into the power to platform GFCI outlet.

To turn off the generator, move the generator toggle switch to the off position.

Note: Machine functions will not operate while the generator is running and the foot switch is not pressed down. When the foot switch is pressed down, the generator will turn off and the machine functions will operate.

Operating Instructions

Machine Not Level Indicator Light



If the tilt alarm sounds when the platform is raised, the Machine Not Level indicator light will come on and the drive function in one or both directions will not operate. Identify the condition of the boom on the slope as shown below. Follow the steps to lower the boom before moving to a firm, level surface. Do not rotate the boom while lowering.

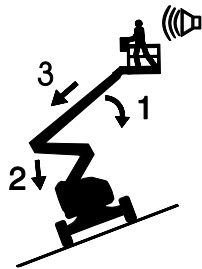

If the tilt alarm sounds with the platform uphill:

- 1 Lower the primary boom.
- 2 Lower the secondary boom.
- 3 Retract the primary boom.

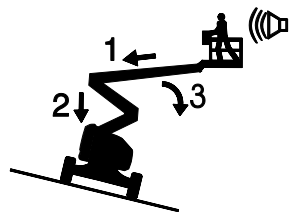

If the tilt alarm sounds with the platform downhill:

- 1 Retract the primary boom.
- 2 Lower the secondary boom.
- 3 Lower the primary boom.

Platform Capacity Selection

Range of motion is controlled automatically based on platform load.

Unrestricted Range of Motion:
When the platform load is less than 300 kg, the unrestricted range of motion light is on.

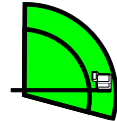

Restricted Range of Motion:
When the platform load is 301-454 kg, the restricted range of motion light is on and the jib function is limited.

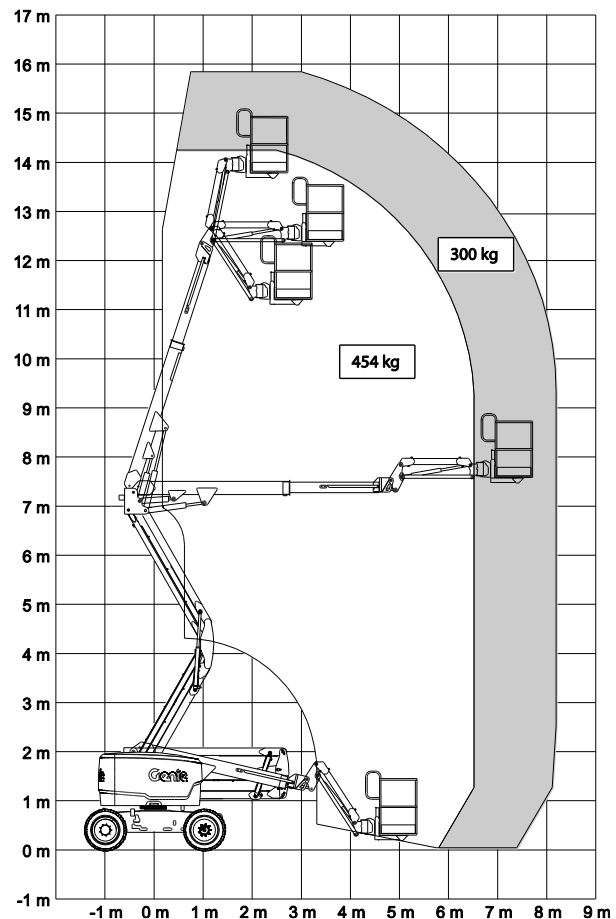

Operating Instructions

Platform Capacity Selection with Aircraft Protection

Range of motion is controlled automatically based on platform load.

Unrestricted Range of Motion:
When the platform load is less than 273 kg, the unrestricted range of motion light is on.

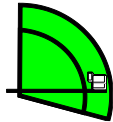

Restricted Range of Motion:
When the platform load is 274-427 kg, the restricted range of motion light is on and the jib function is limited.

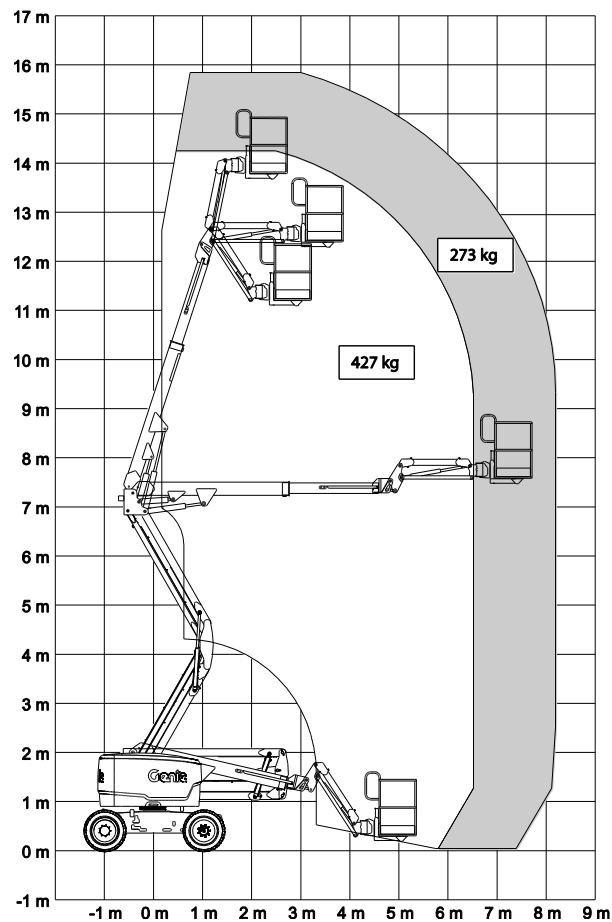

Operating Instructions

Platform Overload Indicator Light



Light flashing indicates the platform is overloaded. The engine will stop and no functions will operate.

Remove weight from the platform until the light goes off and then restart the engine.

Aircraft Protection Package (if equipped)

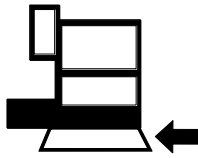

If the platform bumper comes into contact with an object, the machine will shut down and no functions will operate.

- 1 Start the engine.
- 2 Press down the foot switch.
- 3 Move and hold the aircraft protection override switch.
- 4 Move the appropriate function control handle or toggle switch to move the machine away from aircraft components.

After Each Use

- 1 Select a safe parking location—firm level surface, clear of obstruction and traffic.
- 2 Retract and lower the boom to the stowed position.
- 3 Rotate the turntable so that the boom is between the non-steer wheels.
- 4 Turn the key switch to the off position and remove the key to secure from unauthorized use.

Transport and Lifting Instructions



Observe and Obey:

- ☑ Genie provides this securement information as a recommendation. Drivers are solely responsible for making sure machines are properly secured and the correct trailer is selected pursuant to US Department of Transportation regulations, other localized regulations, and their company policy.
- ☑ Genie customers needing to containerize any lift or Genie product should source a qualified freight forwarder with expertise in preparing, loading and securing construction and lifting equipment for international shipment.
- ☑ Only qualified mobile elevating work platform operators should move the machine on or off the truck.
- ☑ The transport vehicle must be parked on a level surface.
- ☑ The transport vehicle must be secured to prevent rolling while the machine is being loaded.
- ☑ Be sure the vehicle capacity, loading surfaces and chains or straps are sufficient to withstand the machine weight. Genie lifts are very heavy relative to their size. See the serial label for the machine weight. See the inspections section for the serial label location.

- ☑ Be sure the turntable is secured with the turntable rotation lock before transporting. Be sure to unlock the turntable for operation.
- ☑ Do not drive the machine on a slope that exceeds the uphill, downhill or side slope rating. See Driving on a Slope in the Operating Instructions section.
- ☑ If the slope of the transport vehicle bed exceeds the uphill or downhill maximum slope rating, the machine must be loaded and unloaded using a winch as described in the brake release operation. See the Specifications section for the slope ratings.

Free-wheel Configuration for Winching

Chock the wheels to prevent the machine from rolling.

4WD models: Release the wheel brakes by turning over all four drive hub disconnect caps.

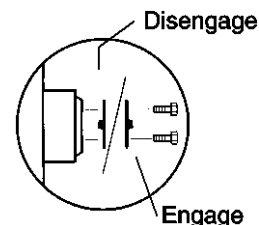

Be sure the winch line is properly secured to the drive chassis tie points and the path is clear of all obstructions.

Reverse the procedures described to re-engage the brakes.

Note: Towing the Genie Z-45 XC is not recommended. If the machine must be towed, do not exceed 3.2 km/h.

Transport and Lifting Instructions

Securing to Truck or Trailer for Transit

Always use the turntable rotation lock pin each time the machine is transported.

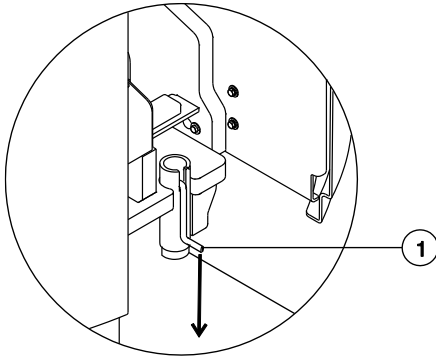

1 Turntable rotation lock pin

Turn the key switch to the off position and remove the key before transporting.

Inspect the entire machine for loose or unsecured items.

Securing the Chassis

Use chains of ample load capacity.

Use a minimum of 4 chains or straps.

Adjust the rigging to prevent damage to the chains.

For diagram, refer to the Lifting Instructions.

Securing the Platform - Z-45 XC, Z-45 HF

Make sure the jib and platform are in the stowed position.

Secure the platform with a nylon strap placed over the platform mount near the platform rotator (see below). Do not use excessive downward force when securing the boom section.

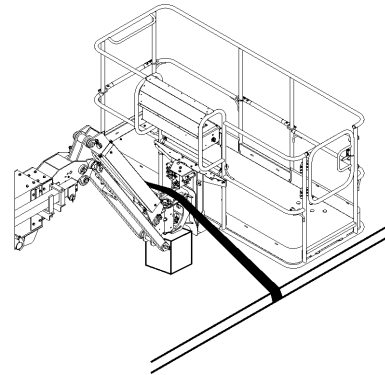

Transport and Lifting Instructions



Observe and Obey:

- ☑ Only qualified riggers should rig the machine.
- ☑ Only certified crane operators should lift the machine and only in accordance with the applicable crane regulations.
- ☑ Be sure the crane capacity, loading surfaces and straps or lines are sufficient to withstand the machine weight. See the serial label for the machine weight.

Lifting Instructions

Fully lower and retract the boom. Fully lower the jib. Remove all loose items on the machine.

Determine the center of gravity of your machine using the table and the picture on this page.

Attach the rigging only to the designated lifting points on the machine.

Adjust the rigging to prevent damage to the machine and to keep the machine level.

Center of gravity	X Axis	Y Axis
Z-45 XC	118 cm	113 cm

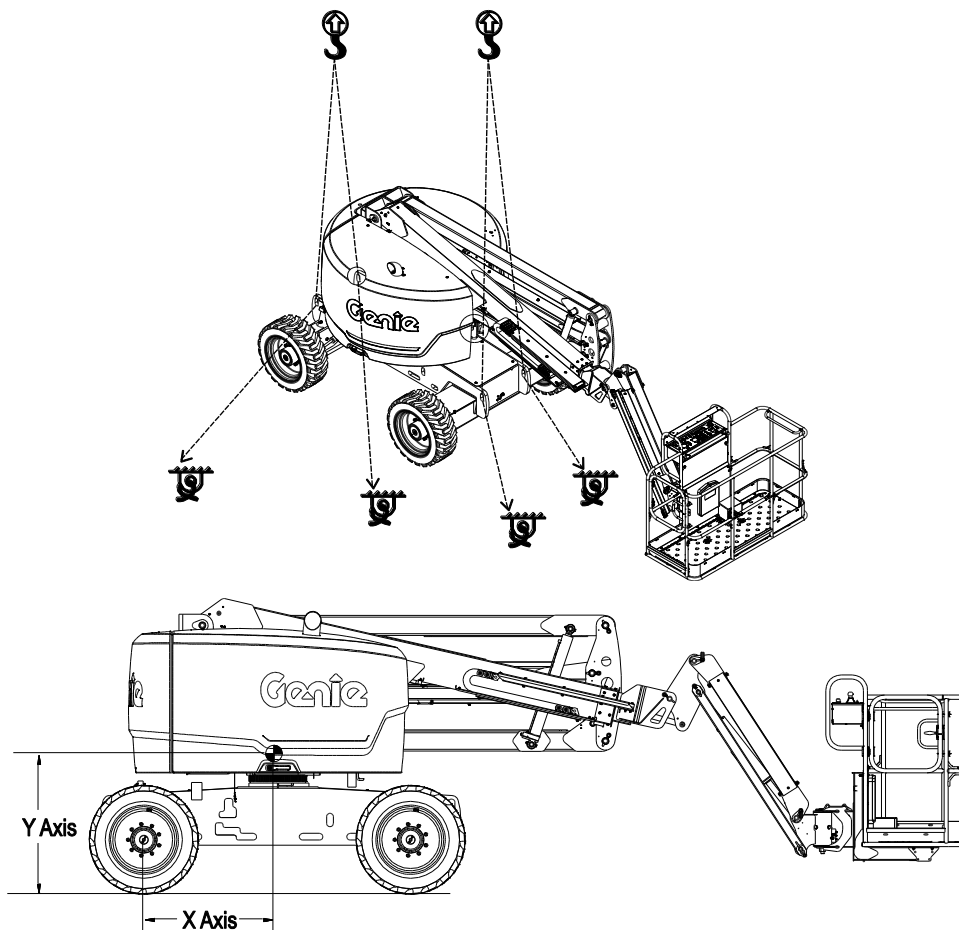

Maintenance



Observe and Obey:

- Only routine maintenance items specified in this manual shall be performed by the operator.
- Scheduled maintenance inspections shall be completed by qualified service technicians, according to the manufacturer's specifications and the requirements specified in the responsibilities manual.
- Dispose of material in accordance with governmental regulations.
- Use only Genie approved replacement parts.

Maintenance Symbols Legend

The following symbols have been used in this manual to help communicate the intent of the instructions. When one or more of the symbols appear at the beginning of a maintenance procedure, it conveys the meaning below.



Indicates that tools will be required to perform this procedure.



Indicates that new parts will be required to perform this procedure.



Indicates that a cold engine is required before performing this procedure.

Check the Engine Oil Level



Maintaining the proper engine oil level is essential to good engine performance and service life. Operating the machine with an improper oil level can damage engine components.

Note: Check the oil level with the engine off.

Check the oil level dipstick. Add oil as needed.

Deutz D2011 L03i Engine

Oil type	15W-40
Oil type - cold conditions	5W-40

Maintenance

Diesel Fuel Requirements



Satisfactory engine performance is dependent on the use of a good quality fuel. The use of a good quality fuel will give the following result: long engine life and acceptable exhaust emissions levels.

Minimum diesel fuel requirements for each engine are listed below.

Deutz D2011 L03i Engine

Fuel Type	Low Sulfur Diesel (LSD)
-----------	-------------------------

Check the Hydraulic Oil Level



Maintaining the hydraulic oil at the proper level is essential to machine operation. Improper hydraulic oil levels can damage hydraulic components. Daily checks allow the inspector to identify changes in oil level that might indicate the presence of hydraulic system problems.

- 1 Be sure that the boom is in the stowed position.
- 2 Visually inspect the sight gauge located on the side of the hydraulic oil tank.
- ⊙ Result: The hydraulic oil level should be within the top 5 cm of the sight gauge.
- 3 Add oil as needed. Do not overfill.

Hydraulic oil specifications

Hydraulic oil type	Chevron Rando HD equivalent
--------------------	-----------------------------

Maintenance

Check the Engine Coolant Level – Liquid Cooled Models



Maintaining the engine coolant at the proper level is essential to engine service life. Improper coolant level will affect the engine's cooling capability and damage engine components. Daily checks will allow the inspector to identify changes in coolant level that might indicate cooling system problems.

- ▲ Burn hazard. Beware of hot engine parts and coolant. Contact with hot engine parts and/or coolant may cause severe burns.
 - ▲ Burn hazard. Do not remove the radiator cap if the engine has been running. Contact with pressurized coolant may cause severe burns. Allow engine to cool before removing the radiator cap.
- 1 Check the fluid level in the coolant recovery tank. Add fluid as needed.
- ◎ Result: The fluid level should be at the FULL mark on the tank or visible in the sight gauge.

Check the Batteries



Proper battery condition is essential to good machine performance and operational safety. Improper fluid levels or damaged cables and connections can result in component damage and hazardous conditions.

- ▲ Electrocution hazard. Contact with hot or live circuits may result in death or serious injury. Remove all rings, watches and other jewelry.
 - ▲ Bodily injury hazard. Batteries contain acid. Avoid spilling or contacting battery acid. Neutralize battery acid spills with baking soda and water.
- 1 Put on protective clothing and eye wear.
 - 2 Be sure that the battery cable connections are tight and free of corrosion.
 - 3 Be sure that the battery hold-down brackets are in place and secure.

Note: Adding terminal protectors and a corrosion preventative sealant will help eliminate the corrosion on the battery terminals and cables.

Maintenance

Scheduled Maintenance

Maintenance performed quarterly, annually and every two years must be completed by a person trained and qualified to perform maintenance on this machine according to the procedures found in the service manual for this machine.

Machines that have been out of service for more than three months must receive the quarterly inspection before they are put back into service.

Specifications

Z-45 XC	
Height, working maximum	15.86 m
Height, platform maximum	13.86 m
Height, stowed maximum	2.25 m
Horizontal reach, maximum	7.55 m
Width, standard tires	2.29 m
Length, stowed	6.66 m
Maximum platform capacity, unrestricted range of motion	300 kg
Maximum platform capacity, restricted range of motion	454 kg
Maximum platform capacity, unrestricted range of motion, models with Aircraft Protection Package	273 kg
Maximum platform capacity, restricted range of motion, models with Aircraft Protection Package	427 kg
Jib articulation	
Up	78°
Down	-57°
Maximum wind speed	12.5 m/s
Wheelbase	2.03 m
Turning radius (outside)	4.5 m
Turning radius (inside)	1.68 m
Turntable rotation	355°
Turntable tailswing	0 cm
Ground clearance, center	37.5 cm
Ground clearance, axle	26.7 cm
Controls	12V DC proportional
Weight	6870 kg
(Machine weights vary with option configurations. See serial label for specific machine weight.)	

Platform dimensions, 6 foot	183 cm x 76 cm
Platform leveling	self-leveling
Platform rotation	160°
AC outlet in platform	standard
Fuel tank capacity	64.4 liters
Hydraulic pressure, maximum (boom functions)	221 bar
System voltage	12V
Tire size	315/55 D20 foam filled

Airborne noise emissions

Sound pressure level at ground workstation	87 dBA
Sound pressure level at platform workstation	82 dBA
Guaranteed sound power level	105 dBA

Total vibration value to which the hand/arm system is subjected does not exceed 2.5 m/s².

Highest root mean square value of weighted acceleration to which the whole body is subjected does not exceed 0.5 m/s².

Maximum slope rating, stowed position, 4WD

Platform downhill	45% (24°)
Platform uphill	25% (14°)
Side slope	25% (14°)

Note: Slope rating is subject to ground conditions with one person in the platform and adequate traction. Additional platform weight may reduce slope rating.

Drive speeds

Drive speed, stowed	7.2 km/h
Drive speed, booms raised	0.14 m/s

Floor loading information

Tire load maximum	4226 kg
Tire contact pressure	5.63 kg/cm ² 552 kPa
Occupied floor pressure	1037 kg/m ² 10.17 kPa

Note: Floor loading information is approximate and does not incorporate different option configurations. It should be used only with adequate safety factors.

Continuous improvement of our products is a Genie policy. Product specifications are subject to change without notice or obligation.

Specifications

Z-45 XC Range of Motion Chart

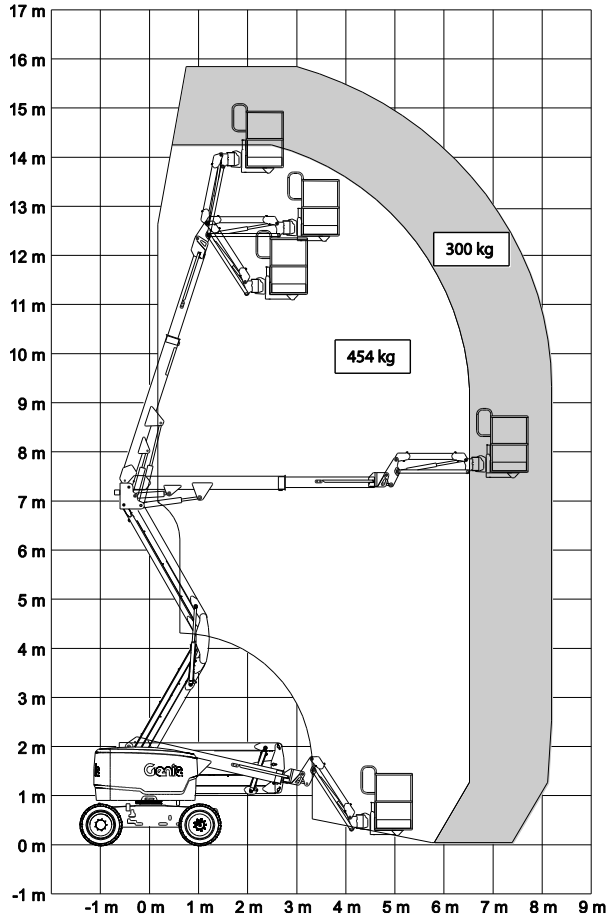

Z-45 XC Range of Motion Chart with Aircraft Protection

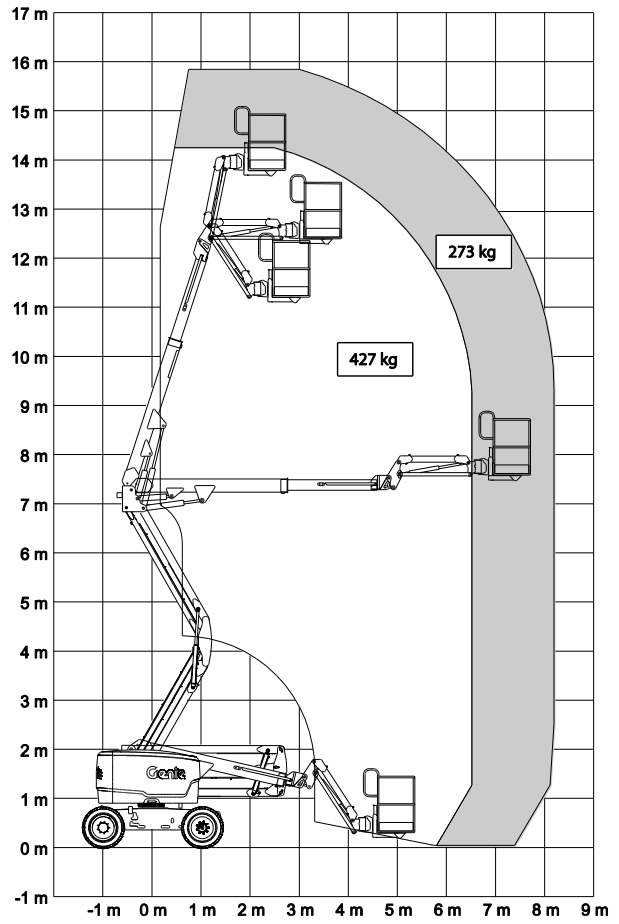

www.genielift.com

Distributed By: