



Maintenance Manual

M0810JE

Mast Mobile Elevating Work Platform



WARNING

Before operation and maintenance, the drivers and service personnel shall always read and thoroughly understand all information in this manual. Failure to do so may result in, fatal accidents or personal injury.

This manual must be kept with this machine at all times.

LINGONG HEAVY MACHINERY CO., LTD.

Mast Mobile Elevating Work Platform Maintenance Manual

880*1230 mm 16 format 8 printed sheets

First edition and printed for the first time in April 2023

Lingong Heavy Machinery Co., Ltd.

Add: 12th Floor, Building 3, Lushanguoaocheng, 9777 Jingshi Road, Lixia District, Jinan, China

Tel: 86-0531-67605017

Technical service: 86-0531-67605017

Web: www.LGMG.com.cn

Sales of accessories: 86-0531-67605016

Contents

Foreword	II
Safety Notices	III
Chapter 1 Maintenance	1
1.1 Checking the Battery	3
1.2 Checking the Hydraulic Oil Level	4
1.3 PDI Report	5
1.4 Maintenance Schedule	5
1.5 Maintenance Inspection Report	6
1.6 PDI Report	7
1.7 Maintenance Inspection Report	8
1.8 Steps for Checklist A	8
1.9 Steps for Checklist B	10
1.10 Steps for Checklist C	17
1.11 Steps for Checklist D	18
1.12 Steps for Checklist E	22
Chapter 2 Appendix	25
2.1 Maintenance items	27

Foreword

Thank you for choosing to use this Mobile Elevating Work Platform from LGMG. This machine is designed according to AS/NZS 1418.10:2011+A1:2017. The information specified in this manual is intended for the maintenance and adjustment data of this machine for its' intended purpose.

For maximum performance and utilization of this machine, thoroughly read and understand all the information in this manual before starting, operating, or performing maintenance on this machine.

Due to continuous product improvements, LGMG reserves the right to make specification changes without any prior notifications. For any updated information, contact LGMG.

Ensure all preventive maintenance to the machine is performed according to the interval specified in the maintenance schedule.

Keep this manual with this machine for reference at all times. When the ownership of this machine is transferred, this manual shall be transferred with this machine. This manual must be replaced immediately if it is lost, damaged, or becomes illegible.

This manual is copyrighted material. The reproduction or copy of this manual is not allowed without the written approval of LGMG.

The information, technical specifications and drawings in this manual are the latest available when this manual is issued. Due to continuous improvement, LGMG reserves the right to change the technical specifications and machine design without notice. If any specifications and information in the manual are not consistent with your machine, please contact the service department of LGMG.

WARNING

Only the personnel who have been professionally trained and qualified are allowed to operate and maintain the machine.

Incorrect operation, maintenance and repair are dangerous and may lead to personal injury or death.

Before operation or maintenance, please read this manual thoroughly. Otherwise, do not operate, maintain or repair this machine.

Please load the machine in strict accordance with the rating; otherwise all the consequences arising from overloading or unauthorized modification will be borne by the user.

The operation instructions and precautions in this manual apply only to the intended use of the machine. If the machine is used for an operation that is out of the specification herein but not prohibited, always make sure that this operation will not cause personal injury to yourself or others.

Please operate the machine in strict accordance with the safety requirements in the manual. The user is responsible for all consequences caused by non-compliance with the safety requirements of the machine.

Safety Notices

The operator shall understand and abide by the current national and local safety regulations. If such regulations are not available, the safety instructions in this manual shall prevail.

Most accidents are caused by failure to obey operation and maintenance specifications of the machine. To avoid unnecessary accident, please read and follow all warnings and precautions in this manual and on the machine before operation or maintenance.

Considering the fact that not all possible hazards are foreseeable, it is impossible for safety notices in this manual and on the machine to cover all safety precautions. If it is necessary to take steps and operations not recommended herein, always protect the safety of yourself and others, and keep the machine from any damage. If the safety of some operations remains uncertain, please consult us or our dealers.

The operation and maintenance precautions referred to herein apply only to the intended use of this machine. If the machine is to be used for other purposes than those listed herein, it is the user or operator instead of us that shall take the safety liabilities therefrom.

In no case shall any operations expressly prohibited herein be performed.

For the purpose of this manual, the following signal words are applied to identify safety instructions:



DANGER - Indicating any existing dangers that, if not avoided, will cause serious injury or even death, and also serious machine damage.



WARNING - Indicating any potential dangers that, if not avoided, may cause death or serious injury, and also serious machine damage.



CAUTION - Indicating situations that, if not avoided, may cause minor or moderate injury, and also machine damage or shortened machine service life.



Chapter 1 Maintenance



 **WARNING:** Observe the regulations

- The operator can only perform the regular maintenance items specified in this manual.
- As required by the manufacturer, the regular maintenance and inspection shall be performed by the trained maintenance technicians.

1.1 Checking the Battery

Keeping the battery in good condition is crucial for superior performance and safe operation. Improper electrolyte level or damaged cable or wiring may cause parts damage and hazards.

 **CAUTION:** If the machine is equipped with the hermetically sealed battery or maintenance-free battery, inspection of electrolyte level is not required. Otherwise, the electrolyte level should be checked.

 **DANGER**

Risk of electric shock:
Live-line working may result in serious personal injury or even death. Be sure

to remove the ring, watch and other ornaments before the work.

Risk of personal injury:

The battery electrolyte is corrosive. Avoid touching the spilled electrolyte with hands or other parts of the body so as to avoid injuries. Use soda and water to neutralize the spilled electrolyte.

 **CAUTION:** The following

inspections should be carried out with sufficient battery power:

- Wear protective clothes and goggles.
- Open the upper cover of the rotary table.
- Ensure that the battery cable is connected firmly, without corrosion.
- Remove the battery cover.
- Check the battery electrolyte level. Add distilled water as needed, and do not add too much.
- Refit the cover.

 **CAUTION:** It is necessary to add the terminal protector and corrosion-resistant sealant to protect the battery terminals and cables against corrosion.

1.2 Checking the Hydraulic Oil Level

Proper hydraulic oil level is crucial in operating the machine. If the hydraulic oil is at an improper level, the hydraulic components will be damaged. Through a daily inspection, the inspector can determine the hydraulic oil level change which indicates that the hydraulic system is faulty.

 **CAUTION: This procedure shall be performed when the machine is retracted.**

- 1) Visually check the oil level sight glass on the side of the hydraulic tank.

Result: The hydraulic oil level should be at the scale of the tank.

- 2) Add the oil as needed, and do not add too much.

 **CAUTION: Please add hydraulic oil according to the operating environment and temperature, as described below:**

Inspection interval	Inspection item
Daily or every 2 h	A
Monthly or every 25 h	A+B
Quarterly or every 50 h	A+B+C
Semiannually or every 100 h	A+B+C+D
Yearly or every 200 h	A+B+C+D+E
Biennially or every 400 h	A+B+C+D+E+F

Key			
Y=Yes			
N=No			
R=Repaired			
Pass/fail			
PDI report	Y	N	R
Operation inspections completed			
Maintenance items completed			
Function tests completed			
Model			
Serial number			
Date			
Owner			
Inspection unit (printed)			
Signature of inspector			
Title of inspector			
Inspection company			

Grade	Brand
Rando MV32	Chevron



CAUTION: Do not top off with incompatible hydraulic fluids. Hydraulic fluids may be incompatible due to the differences in base additive chemistry. When incompatible fluids are mixed, insoluble materials may form and deposit in the hydraulic system, plugging hydraulic lines, filters, control valves and may result in component damage.

1.3 PDI Report

- 1) PDI report covers all PDI items.
- 2) PDI report should be prepared for every PDI item. Fill in the report and save it as required.

1.4 Maintenance Schedule

The daily, quarterly, semiannually, yearly and biennially inspection must be carried out as scheduled. The product maintenance schedule and PDI report are subdivided into five items: A, B, C, D, E. The inspection steps are shown in the left table.



CAUTION:

- Working hours shall prevail for the

maintenance cycle.

- The steering knuckle and slewing bearing should be lubricated monthly to ensure that the equipment meets the operating requirements.

1.5 Maintenance Inspection Report

- 1) Maintenance inspection report covers all maintenance inspection items.
- 2) Maintenance inspection report should be prepared for every maintenance inspection item. After the inspection, the report should be retained for at least 4 years, or as specified by the employer, workplace and government laws and regulations.

Key			
Y=Pass			
N=Fail			
R=Repaired			
Checklist A	Y	N	R
A-1 Checking the manuals and labels			
A-2 Pre-operation inspection			
A-3 Function test			
After 25 h			
A-4 30-day maintenance			
Checklist B	Y	N	R
B-1 Checking the battery			
B-2 Checking the wires			
B-3 Checking the tires and hubs			
B-4 Checking the emergency stop switch			
B-5 Key switch			
B-6 Horn			
B-7 Drive and brake			
B-8 Drive speed in retraction state			
B-9 Drive speed in lifting state			
B-10 Visually checking hydraulic oil			
Checklist C	Y	N	R
C-1 Platform overload system			
C-2 Checking the wire rope			
Checklist D	Y	N	R
D-1 Checking reducer gear oil			
D-2 Checking the mast slider			
D-3 Replacing the hydraulic filter			
D-4 Replacing the hydraulic tank breather cap			
D-5 Checking the lifting chains			
D-6 Lubricate the lifting chains			
Checklist E	Y	N	R
E-1 Testing and changing hydraulic oil			

1.6 PDI Report

1.6.1 Basic Principles

- 1) Dealers are obliged to complete PDI.
- 2) Priority should be given to PDI before each product is delivered. PDI is to find out if there are any obvious problems with the equipment before it is put into use.
- 3) Damaged and modified equipment is never allowed to be used. Once damage or inconsistencies in equipment delivery are found, the machine must be marked and stopped immediately.
- 4) Equipment repairs must be performed by a certified technician, in accordance with the manufacturer's specifications and the requirements in this manual.

1.6.2 Instructions

- 1) Refer to the Operating Manual on the equipment.
- 2) PDI consists of operation inspections, maintenance items and function tests.
- 3) Record the results in a table. Fill in the appropriate table after each item is completed according to the instructions in the Operating Manual.
- 4) If the result of any inspection is "N", stop the equipment, and conduct repair and recheck.

Afterwards, mark the R column.

1.7 Maintenance Inspection Report

	Daily or every 2 h	A
	Monthly or every 25 h	A+B
	Quarterly or every 50 h	A+B+C
	Semiannually or every 100 h	A+B+C+D
	Yearly or every 200 h	A+B+C+D+E
	Biennially or every 400 h	A+B+C+D+E+F

CAUTION:

- Record each inspection in a report.
- Select the appropriate checklist according to the inspection items.
- Check the appropriate box after each inspection.
- Learn how to perform the inspection step by step.
- If the inspection result is "N", mark and stop the equipment, and conduct repair and recheck. After the repair, check the "R" column. ①
PDI②Operation inspections completed③Maintenance items completed④Function tests completed

1.8 Steps for Checklist A

A-1

Checking the manuals and labels

Keeping the operation and maintenance manuals intact is the key to safe operation. Each equipment is supplied with manuals, which are stored in the box on the platform. Manuals with faint handwriting or missing pages do not provide

enough information to ensure safe operation.

In addition, be sure that all safety labels are in good condition. The labels warn the operator of safety hazards associated with the use of the machine. They also provide the user with operation and maintenance information. Blurred labels will not serve as a warning and may lead to a hazardous operating environment.

- 1) Check that the operation and maintenance manuals are in the box on the platform.
- 2) Check that the manuals are legible and complete.

Result: The manuals match the model, and all manuals are legible and complete.

Result: The manuals do not match the model, or they are illegible or incomplete. Stop the machine before manual replacement.

- 3) Check if the labels are illegible or damaged against the label inspection chart carefully.

Result: All labels are complete, legible and intact.

Result: Some labels are missing, illegible or damaged. Stop the machine before the label replacement.

- 4) Put the manuals back to the original place after use.

Notice: To replace the manuals or labels, please contact LGMG.

A-2

Pre-operation inspection

Completing the pre-operation inspection is crucial for safe operation of the machine. The pre-operation inspection is completed by visual inspection before the machine is operated. This inspection is used to identify any obvious problems with the machine prior to function test and also to determine if routine maintenance procedures should be performed.

The complete inspection procedure can be found in the "Pre-operation Inspection" section of the Operating Manual.

A-3

Function test

Completing the function test is crucial for safe operation of the machine. Function test is used to find any functional defects in the machine before it is put into operation. A defective machine should not be used. As soon as a functional defect is found, the machine should be marked and stopped immediately.

The complete procedure can be found in the "Function Test" section of the Operating Manual.

A-4

30-day maintenance

The 30-day maintenance is a one-time maintenance after the first 30 days or 25 hours of machine operation. After this step, proceed to the maintenance items on the checklist.

Perform the following maintenance:

For example:

- 1) B-3 Checking the tires and hubs

1.9 Steps for Checklist B

B-1

Checking the battery

This inspection shall be performed once every 25 h or every month, whichever comes first.

Keeping the battery in good condition is crucial for superior performance and safe operation of the machine. Improper electrolyte level or damaged cable or connector may cause parts damage and hazards.

 **WARNING: Risk of electric shock**

Live-line working may result in serious personal injury or even death. Be sure to remove the ring, watch and other ornaments before the work.

 **WARNING: Risk of personal injury**

The battery electrolyte is corrosive. Avoid touching the spilled electrolyte with hands or other parts of the body so as to avoid injuries. Use soda and water to neutralize the spilled electrolyte.

- 1) Wear protective clothes and goggles properly.
- 2) Open the upper cover of the rotary table.
- 3) Ensure that the battery cable connectors are

not corroded.

 **CAUTION: Adding terminal**

protectors or applying anti-corrosion sealant may avoid corrosion of the battery cable connectors.

- 4) Ensure that the battery and cables are fixed securely.
- 5) Fully charge the batteries and maintain the charge for at least 24 hours.

 **CAUTION: Steps 6-12 do not apply**

to maintenance-free batteries and hermetically sealed batteries.

- 6) Open the battery cell cover(s), check the specific weight with a specific gravity hydrometer and record the value.
- 7) Check ambient temperature and adjust the specific liquid gravity of each battery according to the instructions in the following steps.

Increase the specific liquid gravity by 0.004 per 5°C, if the temperature is higher than 27°C.

Decrease the specific liquid gravity by 0.004 per 5°C, if the temperature is lower than 27°C.

Result: The specific liquid gravity of each battery is greater than 1.277 after the adjustment. Fully charge the battery and turn

to Step 11.

Result: If the specific liquid gravity of each battery is lower than 1.250, turn to Step 8.

- 8) Charge the battery in a balanced way or fully charge the battery and maintain the charge for at least 6 hours (preferably 24 hours).
- 9) Open the battery cell cover(s), check the specific weight with a specific gravity hydrometer and record the value.
- 10) Check ambient temperature and adjust the specific liquid gravity of each battery according to the instructions in the following steps.

Increase the specific liquid gravity by 0.004 per 5°C, if the temperature is higher than 27°C.

Decrease the specific liquid gravity by 0.004 per 5°C, if the temperature is lower than 27°C.

Result: the specific liquid gravity of each battery is greater than 1.277 after the adjustment. Fully charge the battery and turn to Step 11.

Result: the specific liquid gravity difference between the battery cells is greater than 0.1 or the specific liquid gravity of more than one battery cell is less than 1.217. In such case, please replace the battery.

- 11) Check the battery acid level. If needed, replenish with distilled water until the white buoy floats to the top. Do not overfill.

- 12) Install the vent caps and neutralize any electrolyte that may have spilled.

 **CAUTION: The following steps apply to all batteries.**

- 13) Check the battery charger plug and wire insulation for excessive wear and damage, and replace them in time if necessary.
- 14) Connect the battery charger to AC power supply of 100-240V, 50-60HZ correctly.

Result: The charger charges the battery.

Result: The audible alarm of the charger is triggered and the indicator lamp flashes. Check and correct the connection of fuse and charger. Ensure that the charger works normally and charges the battery.

 **CAUTION:**

For good effect, please select the wire of appropriate length. The overall length of wire shall not exceed 15 m.

To know more problems on charger operation, please contact the after-sales service department of LGMG.

B-2

Checking the wires

This inspection shall be performed once every 25 h or every month, whichever comes first.

Keeping the wires in good condition is crucial for

safe operation and superior performance of the machine. Failure to find and replace the burned, scratched, corroded or bent wires will lead to an unsafe operating environment, causing damage to the machine parts.



DANGER: Risk of electric shock/

explosion

Contact with live circuits may cause serious personal injury or death. Do not wear rings, watches or other ornaments.

- 1) Press the red emergency stop buttons on PCU and GCU.
- 2) Turn the key switch to “OFF” position.
- 3) Turn off the main power switch.
- 4) Check if the ground wire under the chassis is missing or damaged.
- 5) Check for burnt, scratched, corroded, bent or loose wires in the followings areas:
 - GCU box
 - Hydraulic valve group
 - Battery pack
 - Guard plate of front cover of chassis
- 6) Check for burnt, scratched, corroded, bent or loose wires in the chassis and mast areas.
- 7) Check for burnt, scratched, corroded, bent or loose wires in the following areas:
 - Mast
 - ECU to platform

Harness connectors connected to the platform

- 8) Check the free coating of insulating oil applied to the following parts:
 - Harness connectors between ECU and PCU.
- 9) Check the electrical contactor for:
 - Excessive pitting
 - Excessive burn

B-3

Checking the tires and hubs

This inspection shall be performed once every 25 h or every month, whichever comes first.

Keeping the tires and hubs in good condition is crucial for safe operation and superior performance of the machine. Any failure of the tires and hubs may cause rollover of the machine. If the failure isn't found or eliminated in time, the machine parts will be damaged.

- 1) Check the tire tread and side for scratch, crack, puncture and other abnormal wear.
- 2) Check the hub for damage, bending and crack.
- 3) Check if the rim bolts are tightened to the torque of 110-130 N.m.

B-4

Checking the emergency stop function

- 1) This inspection shall be performed once every 25 h or every month, whichever comes

first.

- 2) Normal emergency stop function is crucial for safe operation of the machine. If abnormal, the red emergency stop button will not be able to cut off the power supply and stop the machine, causing hazards.

- ① Turn the key switch to GCU position, and screw out the red emergency stop buttons of GCU and PCU.
- ② Set the red emergency stop button of GCU to “OFF” position.
- ③ Operate the machine with the GCU.

Result: The machine does not work.

- ④ Turn the key switch to PCU position, and screw out the red emergency stop buttons of GCU and PCU.
- ⑤ Set the red emergency stop button of PCU to “OFF” position.
- ⑥ Operate the machine with the PCU.

Result: The machine does not work.



CAUTION: All operations of the machine can be stopped by the red emergency stop button of GCU, even though the key switch is set to PCU position.

B-5

Testing the key switch

- 1) This inspection shall be performed once

every 25 h or every month, whichever comes first.

- 2) Normal key switch is crucial for safe operation of the machine. The machine may be operated by the GCU or PCU, which is switched through the key switch. Failure of the switch may cause hazards.

- ① Screw out the red emergency stop buttons of GCU and PCU.
- ② Turn the key switch to PCU position.
- ③ Check the lifting and lowering function of the GCU.

Result: The machine does not work.

- ④ Turn the key switch to GCU position.
- ⑤ Check the lifting and lowering function of the PCU.

Result: The machine does not work.

- ⑥ Turn the key switch to “OFF” position.

Result: The machine does not work.

B-6

Testing the horn

- 1) This inspection shall be performed once every 25 h or every month, whichever comes first.
- 2) The horn is used by the platform personnel to warn the ground personnel. Abnormal horn cannot warn the ground personnel of

hazards or unsafe conditions.

- ① Turn the key switch to PCU position, and screw out the red emergency stop buttons of GCU and PCU.

- ② Press the horn button.

Result: The horn sounds.

B-7

Testing the drive and brake function

- 1) This inspection shall be performed once every 25 h or every month, whichever comes first.
- 2) Correct braking is crucial for safe operation. Steady braking without delay, jolt or abnormal noise is required.
- 3) The braking function test must be carried out with the machine placed on a solid, level and unobstructed ground and in retraction state.
 - ① Draw a reference test line on the ground.
 - ② Turn the key switch to PCU position, and screw out the red emergency stop buttons of GCU and PCU.
 - ③ Lower the platform to the retraction position.
 - ④ Press the drive function activation button. Then the indicator lamp comes on.
 - ⑤ Take one point (such as the contact point between the wheel and the ground)

on the machine as the mark for visual inspection of misalignment with the reference test line.

- ⑥ Run the machine at the highest speed, and release the joystick immediately when the reference point goes beyond the reference test line on the ground.

- ⑦ Measure the distance between the reference point and the reference test line.

Result: The machine stops within the specified braking distance. The machine meets the requirement and no action is required.

Result: The machine does not stop within the specified braking distance. Replace the brake and repeat the above process starting from step 1



The brake must be effective within the permissible gradeability range of the machine.

B-8

Testing the drive speed in retraction state

- 1) This inspection shall be performed once every 25 h or every month, whichever comes first.
- 2) Normal drive function is crucial for safe

operation. The drive function shall enable the machine to respond to the operator quickly and steadily. No delay, jolt or abnormal noise shall occur during normal operation and traveling.

- 3) The drive test must be carried out with the machine placed on a solid, level and unobstructed ground.
 - ① Draw two lines 10 m spaced apart on the ground, which are taken as the starting and finishing lines respectively.
 - ② Turn the key switch to PCU position, and pull up the red emergency stop buttons of GCU and PCU.
 - ③ Lower the platform to the retraction position.
 - ④ Press the drive function activation button. Then the indicator lamp comes on.
 - ⑤ Take one point on the machine as the reference mark for visual inspection of misalignment with the starting and finishing lines.
 - ⑥ Run the machine at the highest speed and start timing when the reference point goes beyond the starting line.
 - ⑦ Keep running the machine at the highest speed and record the time when the

reference point goes beyond the finishing line. See the specifications.

B-9

Testing the drive speed in lifting state

- 1) This inspection shall be performed once every 25 h or every month, whichever comes first.
- 2) Normal drive function is crucial for safe operation. The drive function shall enable the machine to respond to the operator quickly and steadily. No delay, jolt or abnormal noise shall occur during normal operation and traveling.
- 3) The drive speed test must be carried out with the machine placed on a solid, level and unobstructed ground.
 - ① Draw two lines 10 m spaced apart on the ground, which are taken as the starting and finishing lines respectively.
 - ② Turn the key switch to PCU position, and screw out the red emergency stop buttons of GCU and PCU.
 - ③ Press the mast lifting/lowering function activation button. Then the indicator lamp comes on.
 - ④ Press the enable switch.
 - ⑤ Lift the platform to a certain height.

- ⑥ Press the drive function activation button.
Then the indicator lamp comes on.
- ⑦ Take one point (such as the contact point between the wheel and the ground) on the machine as the reference mark for visual inspection of misalignment with the starting and finishing lines.
- ⑧ Run the machine at the highest speed and start timing when the reference point goes beyond the starting line.
- ⑨ Keep driving the machine at the highest speed and record the time when the reference point goes beyond the finishing line. See the specifications.

B-10

Visually checking hydraulic oil

- 1) This inspection shall be performed once every 25 h or every month, whichever comes first.
- 2) Changing or testing hydraulic oil is crucial for superior performance and service life of the machine. Contaminated hydraulic oil may affect the machine performance and if not changed, will cause damage to the machine. Frequent inspection shall be carried out in a harsh working environment.

Visually checking hydraulic oil

Collect a sample of hydraulic oil and place it in a

transparent container. Visual inspection of the hydraulic oil is performed as follows:

- Color: The oil should be clear and light honey in color.
- Appearance: The oil should be clear, not cloudy, and should not distort when viewed through a sight glass or container.
- It should be free of particles, foreign matter or other contaminants.
- Hydraulic oil can be checked by smell ("hot" but not "burnt") or by rubbing between fingers (a feeling of stickiness without any roughness of particles). If the hydraulic oil passes all of the above inspections, proceed to maintenance as scheduled. In case of failure in any of the above inspections, the hydraulic oil must be checked or changed by the oil dispenser.

Note: If the hydraulic oil has not been changed within two years, it must be checked by the oil dispenser on a quarterly basis and changed in case of failure to pass the check. After oil change, routine scheduled quarterly maintenance inspection should be carried out.

- 3) Before oil change, the oil separator can be used to test if oil change is necessary.
- 4) If the hydraulic oil has not been changed for two years, it should be tested quarterly and

changed if it fails the test.

1.10 Steps for Checklist C

C-1

Testing the platform overload system

- 1) This inspection shall be performed once every 50 h or every quarter, whichever comes first. In case of overload of the machine, inspection and recalibration should be conducted immediately.
- 2) Frequent test of the platform overload mechanism is crucial for safe operation of the machine. Continued incorrect operation of the platform will cause failure of the system to sense the platform overload information and affect the machine stability, leading to rollover of the machine.

C-2

Checking the wire rope

- 1) This inspection shall be performed once every 50 h or every quarter, whichever comes first.
- 2) Raise the platform to a certain height.

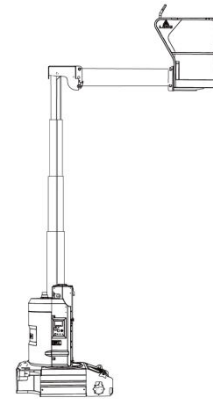

- 3) Place a lifting strap from an overhead crane under the platform. Support the platform. Do not apply lifting pressure.
- 4) Locate the covers located on the first arm, second arm and third arm and remove the covers.

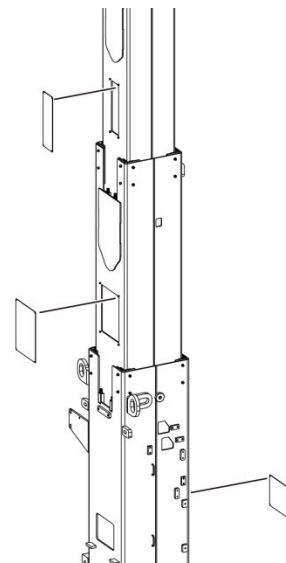

- 5) The wire rope is free from looseness, broken wires and serious rust. If any abnormality is found, please stop using it immediately and hang the fault sign.
- 6) More frequent inspection or replacement (if

necessary) is required when:

- The machine is operated in harsh environment;
- The mast involves seizure or unusual noise during operation;
- The machine is out of service for a long time;
- The mast is exposed to electric arc, by which the strands in the rope may be fused together.

Please refer to the **Service manual** for steps for replacement of boom cables:

How to replace the wire rope.

1.11 Steps for Checklist D

D-1

Checking the gear oil level of driving reducer

- 1) This inspection shall be performed once every 100 h or every six months, whichever comes first.
- 2) Regular inspection of gear oil level is crucial for superior performance and service life of the machine. The oil level should be checked frequently in harsh operating conditions.



- Drive the equipment to rotate until one plug is horizontal and the other is at the high point.
- Remove the plug at horizontal viewing port 2 and check the oil level.

Result: The oil level shall be flush with the bottom of viewing port 2.

- Add gear oil through oil filler 1 as needed until the oil level is flush with the bottom of viewing port 2.
- Apply the pipe thread sealant to the plug, and install the plug into the reducer.
- Repeat this step for each driving reducer.

D-2

Checking the mast slider

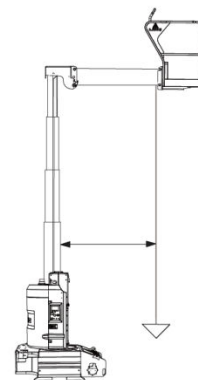

This inspection shall be performed once every 100 h or every six months, whichever comes first. Appropriate thickness and lubrication of the mast slider are crucial for superior performance and

service life of the machine. Damaged slider may cause unsafe operation of the machine.

Move the machine to a solid and level ground.

- 1) Install the appropriate length of plumb line on the platform as shown in the figure.
- 2) Use a suitable lifting device to place the 200 Kg test weight in the center of the platform.
Fix the weight to the platform.
- 3) Lift the jib to the horizontal position with the GCU.
- 4) Lift the mast slowly and completely.
- 5) As shown, use a suitable measuring device to measure the distance between the plumb line and the surface of one section of the mast.

Result: The distance between the plumb line and the surface of one section of the mast does not exceed 1608 mm. No replacement is required and the slider should be greased.

Result: The distance between the plumb line and the surface of one section of the mast exceeds 1608 mm. Renew the slider.

D-3

Replacing the hydraulic filter

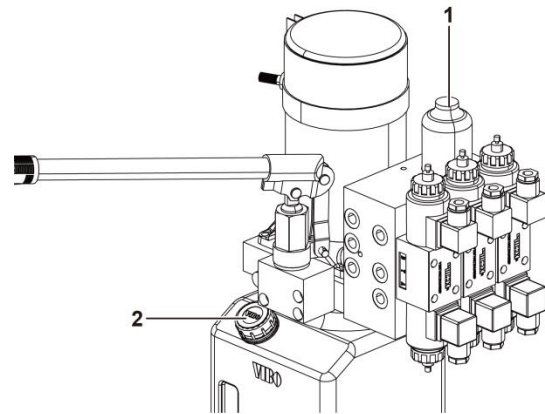

1. Hydraulic filter
2. Breather cap

- 1) This procedure shall be performed once every 100 h or every six months, whichever comes first.
- 2) Replacement of the hydraulic tank return filter is essential for good machine performance and service life. A dirty or clogged filter may cause the machine to perform poorly and continued use may cause component damage. Extremely dirty conditions may require that the filter be replaced more often.

 **WARNING: Beware of hot oil.**

Contact with hot oil may cause severe burns.

- 3) Park the machine on a solid and level ground.
- 4) Turn the key switch to off position and push in the red emergency stop button to the off

position at both the ground and platform controls.

- 5) Locate the filter of the function manifold.
Clean the area around the filter.
- 6) Remove the filter flange of the manifold.
- 7) Remove the old filter and install a new one.
- 8) Refit the filter flange.
- 9) Use a marker to write down the replacement date on the filter replacement record.
- 10) Implement any mast function with the GCU.
- 11) Check the filter components for oil leakage.

D-4

Replacing the hydraulic tank breather cap

- 1) This procedure shall be performed once every 100 h or every six months, whichever comes first.
- 2) If the breather cap is faulty or improperly installed, impurities can enter the hydraulic system which may cause component damage. Extremely dirty conditions may require that the cap be inspected more often.
- 3) Remove the old breather cap.
- 4) Install a new breather cap.

D-5

Checking the lifting chains

- 1) This inspection shall be performed once every 100 h or every six months, whichever comes first.
- 2) Raise the platform to a certain height.

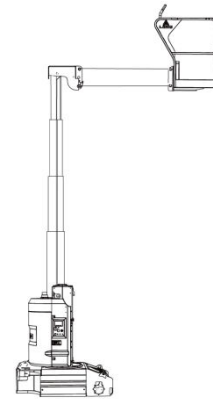

- 3) Place a lifting strap from an overhead crane under the platform. Support the platform. Do not apply lifting pressure.
- 4) Locate the covers located on the third arm and fourth arm and remove the covers to check the inner chains.

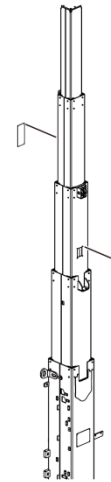

- 5) To carry out the following operations:
 - Check that the lifting chains and safety chains are clean.
 - Check that there are no foreign particles on the chains and guide.
 - Check that there are no signs of corrosion on chain elements.
- 6) Chains with any of the defects described

below must be replaced.

- External wear must not measure more than 2 % from the section of the original link.
- Elongation of up to 2 %, over 12 segments, of the original chain length is permitted.
- Check that no line or element is damaged or missing.
- Check that links are not distorted, deformed or broken.
- Check the connection points of links (the lines must be parallel).

Link width	Length of 12 links
14.4mm	152.4mm
22.7mm	190.5mm
32.2mm	190.5mm

D-6

Lubricate the lifting chains

- 1) This inspection shall be performed once every 100 h or every six months, whichever comes first.
- 2) Lubricated chains are essential to good machine performance and safe operation. Extremely dirty conditions may require that the chains be cleaned and lubricated more often.
- 3) Raise the platform to the maximum height.
- 4) Place a lifting strap from an overhead crane under the platform. Support the platform. Do not apply lifting pressure.

- 5) Before applying new lubricant, remove any foreign particles from the chain.
- 6) Lubricate each chain with a dry spray lubricant.
- 7) There are three positions that require lubrication.

1. Front side of fourth arm.

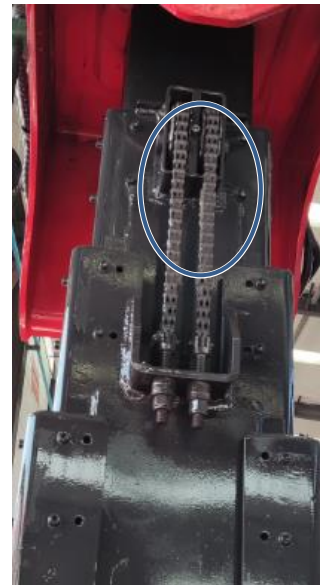

2. Inside of fourth arm cover plate.

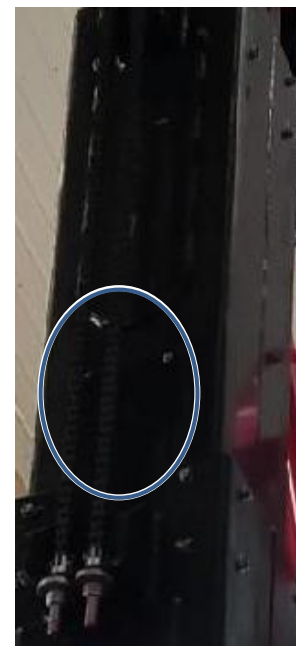

3. Rear side of third arm.



two years, it shall be checked on a quarterly basis and changed in case of failure to pass the check.

⚠ CAUTION: The battery pack should be disconnected with the machine retracted.

⚠ WARNING: Working on live circuits may cause serious personal injury or death. Be sure to remove the ring, watch and other ornaments before the work.

⚠ WARNING: Operating the machine without oil may cause damage to the hydraulic pump. Take care to bleed the tank when adding oil to the hydraulic system. Cavitation is not allowed in the hydraulic pump.

- 8) After lubrication, lift the platform several times.

1.12 Steps for Checklist E

E-1

Testing or changing the hydraulic oil

- 1) This procedure shall be performed once every 200 h or every year, whichever comes first.
- 2) Changing or testing hydraulic oil is crucial for superior performance and service life of the machine. Contaminated hydraulic oil may affect the machine performance and if not changed, will cause damage to the parts.
The oil level should be checked frequently in harsh operating conditions.
- 3) Before oil change, use the oil separator to test if oil change is necessary.
- 4) If the hydraulic oil has not been changed in

Chapter 2 Appendix

2.1 Maintenance items

Routine inspection and maintenance intervals

Maintenance level	Routine inspection	Level 1 maintenance	Level 2 maintenance	Level 3 maintenance	Level 4 maintenance	Level 5 maintenance
Maintenance cycle	Daily	25h/1m	50h/3m	100h/6m	200h/12m	400h/24m



NOTE: Working hours shall prevail for the maintenance cycle.

Maintenance items are listed in the table below

Item	Operation	Level					
		Routine inspection	Level 1 maintenance	Level 2 maintenance	Level 3 maintenance	Level 4 maintenance	Level 5 maintenance
Electrical System	Check battery capacity		•	•	•	•	•
	Check liquid level in battery refueling device and add distilled water		•	•	•	•	•
	Check if buttons on the PCU panel operate normally	•	•	•	•	•	•
	Check if PCU emergency switch is firmly	•	•	•	•	•	•
	Check if switch operation is sensitive	•	•	•	•	•	•
	Check if the PCU harness connector is connected firmly	•	•	•	•	•	•
	Check if the PCU harness connector is stained	•	•	•	•	•	•
	Check if the PCU harness is extruded or broken	•	•	•	•	•	•
	Check if the pressure sensor is connected firmly	•	•	•	•	•	•

	Check if the lowering solenoid valve is connected firmly	•	•	•	•	•	•
	Check if the tilt sensor wiring is connected firmly	•	•	•	•	•	•
	Check if limit switch rocker arms are wired loosely	•	•	•	•	•	•
	Check if emergency stop switches, key switch, connector switch and wiring on the ground control panel are loose	•	•	•	•	•	•
	Check alarm light and horn function are good	•	•	•	•	•	•
	Check if the motor, motor controller, relay and ECU wiring are loose	•	•	•	•	•	•
	Check if the solenoid valve coils of main valve block are wired normal or loose	•	•	•	•	•	•
	Check if the charger wiring is looser rusted	•	•	•	•	•	•
	Check if the charger terminals are loose or rusted	•	•	•	•	•	•
	Check the battery		•	•	•	•	•
	Check overall machine performance and all limited switches	•	•	•	•	•	•
	Check if all connectors are loose or rusted	•	•	•	•	•	•
	Check the clearance of proximity switch				•	•	•
	Calibrate the platform overload system				•	•	•
Hydraulic system	Check if the rotating system pressure is normal			•	•	•	•

	Check if the lifting pressure system is normal			•	•	•	•
	Check if the steering system pressure is normal			•	•	•	•
	Check if all pipes and connectors are loose	•	•	•	•	•	•
	Check if the oil cylinder leaks oil	•	•	•	•	•	•
	Check if the valve spools leak oil	•	•	•	•	•	•
	Check the hydraulic oil level	•	•	•	•	•	•
	Inspect the breather cap			•	•	•	•
	Replace the breather cap	Every six months					
	Replace the hydraulic filter	Every six months					
	Replace hydraulic oil	Per year					
Overall system	Replace reducer lubrication oil	First maintenance: After 50 hours; time interval: 200 hours					
	Check if the machine bolts are loose or have abnormal noise	•					
	Check if the emergency lowering device is normal	•					
	Check if the platform, mast and chassis are deformed or unweld.	•					
	Check if the machine paint falls off	•					
	Check if the safety labels are missing or stained	•					
	Check if the manual and labels are missing, stained or damaged	•					
	Check overall machine performance and all limited switches	•					
	Check if the chains is				•	•	•

	wear, broken and serious rust						
	Check if the wire rope is looseness, broken wires and serious rust			•	•	•	•
	Check the rotation bearing bolts	Every year. Torque:120±10N.m					
	Check the slew reducer bolts	Every six months. Torque: Torque: 120±10N.m					
	Replacement of wire rope	Every ten years					
Lubrication system	Lifting chains lubrication	100h or six months, whichever comes first.					
	Rotation bearing lubrication	Per month					
	Steering knuckle lubrication	Per month					

Selection of oil products

Grade	Hydraulic oil brand
Rando MV32	Chevron

Minimum temperature	Gear oil model (API GL-5)
30°C<The lowest temperature	SAE 85W/140
-10°C<The lowest temperature<30°C	SAE 85W/90
-30°C<The lowest temperature<-10°C	SAE 80W/90
The lowest temperature<-30°C	SAE 75W

Electrical Schematic Diagram

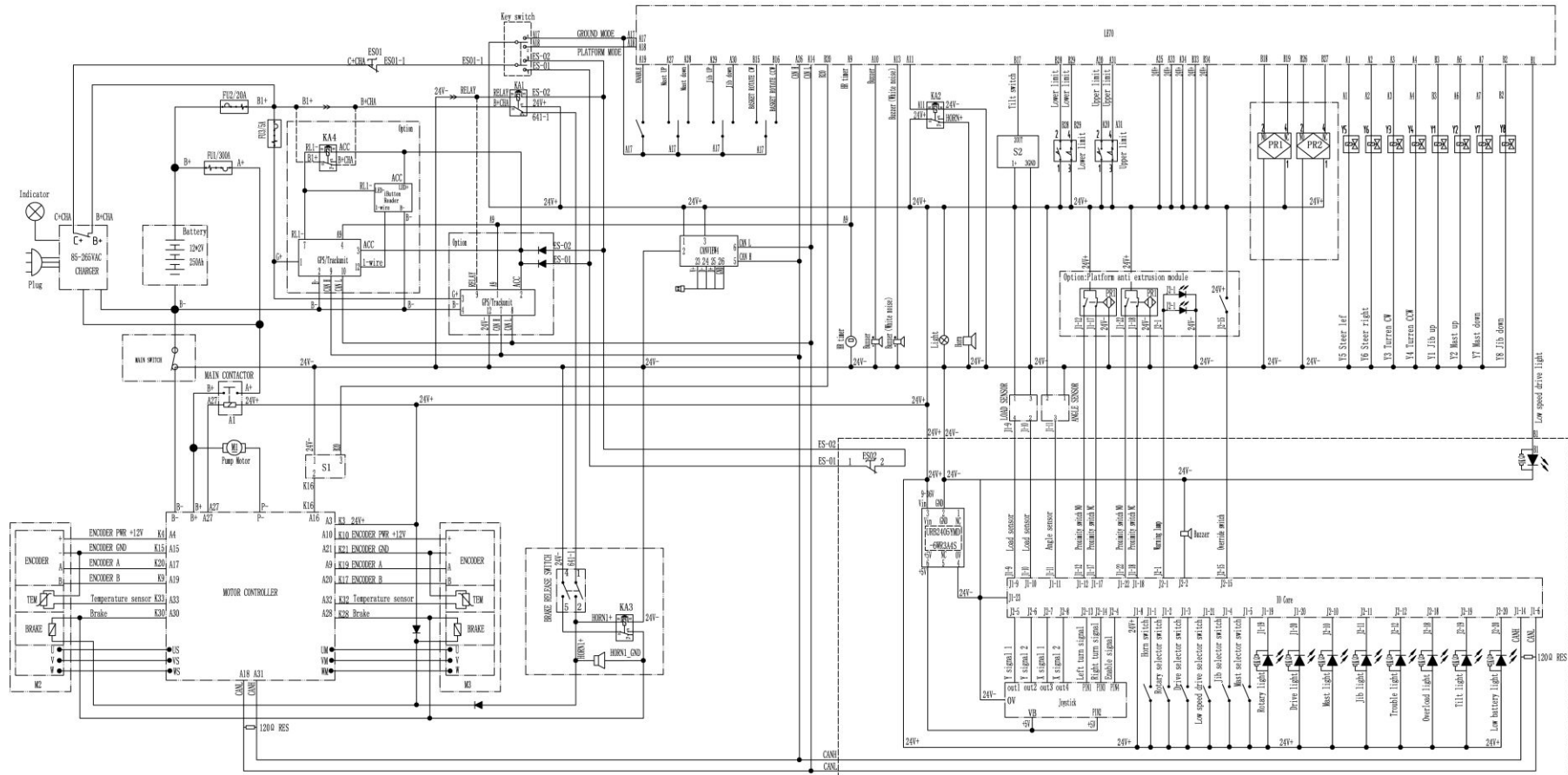

Hydraulic Schematic Diagram

